

Technical
CATALOGUE



Wire Thread Inserts





Recoil

World Wide consistency of quality

Total commitment to quality and service

Comprehensive range of products

Efficient international freight service

Highest quality manufacturing capability

INTRODUCTION	2
PRODUCT RANGE	3
RECOIL INSERTS	4
LOCKING INSERTS	7
FINISHES & COATINGS	9
STI TAPS	15
GAUGES	23
HAND INSTALLATION TOOLS	25
POWER TOOLS	28
STRIP-FEED INSERTS	30
THREAD REPAIR KITS	31
DESIGN CONSIDERATIONS	33



Recoil manufacturing operations are located in Australia, with sales and warehouse facilities strategically located in North America, Asia and Europe. Extensive world wide distribution, coupled with Recoil's manufacturing strategy offers significant advantages to end users.

Recoil ensures a global consistency of quality design standards in manufacturing the full range of wire thread inserts in one production facility. Users around the world can be assured of Recoil's high standards and consistency of products.

Inserts are manufactured in standard sizes for all metric and inch thread forms. A comprehensive design facility is available to ensure that non standard inserts can be manufactured for special part requirements.

Recoil ensures prompt availability of products to customers world wide by employing an efficient international freight service and network of stocking distributors.

Recoil is committed to the highest quality product and operating systems and employs a strict quality management system in accordance with:

- ISO9001 accreditation
- QS9000 accreditation
- Society of British Aerospace Companies (SBAC) TS 157 approval
- Civil Aviation Authority (Australia)
- GM (General Motors)
- Ford
- Chrysler
- TUV of Germany

Recoil's high quality standards demand that every batch of inserts are subjected to multiple visual, dimensional and functional checks at pre-determined intervals throughout the production process, utilising the latest high precision test equipment.

Recoil will provide technical assistance to production engineers so that optimum installation efficiency can be achieved and maintained.

Recoil manufacture to the following manufacturing capability standards:

- MS122076 Series - Free Running - UNC
- MS124651 Series - Free Running - UNF
- MS21209 Series - Locking
- MIL-I-8846
- BS7751 - Metric - Coarse
- BS7752 - Metric - Fine
- BS7753
- BS 4377
- MA3279, MA3280, MA3281 - Metric - Free Running
- MA3329, MA3330, MA3331 - Metric - Self Locking
- AS6733 Series - UNF - Unplated
- AS8455 Series - UNF - Cadmium Plated
- AGS3600 Series - UNF - Cad. Plated - Self Locking
- AGS3700 Series - Nimonic Alloy 90 - Self Locking
- General Electric - C981, N926 Series
- LN 9499, LN 9039
- DIN 8140

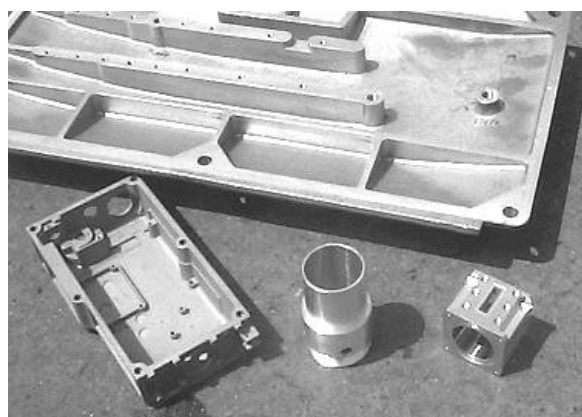

Thread Inserts

The Recoil system consists of precision inserts, quality high speed taps and easy to use installation tools which are used for repairing damaged screw threads or creating strong new threads. Recoil helically wound screw-thread inserts are generally manufactured from Type 304 (18-8) stainless steel wire cold rolled into a diamond shaped cross section. Recoil inserts can be supplied in other materials such as Inconel, Nimonic 90, Phosphor Bronze and Type 316 stainless steel.

Recoil inserts are available in either standard free running form or screw lock type which provides an internal locking feature. Inserts are manufactured for every thread form including UNC, UNF, BSC, BSW, BSP, BSF, BA, NPT and ISO Metric thread sizes.

Thread Repair Kits

Recoil has developed a full range of thread repair kits covering the majority of sizes commonly in use today. Recoil Kits contain a HSS tap, installation tools, precision stainless steel inserts and instructions in a sturdy reusable container. Recoil has a full range of problem solving repair kits available in single or multiple size format.

Installation Tooling

Recoil also offer a selection of work arms and power tooling, including high efficiency pneumatic and electric installation tools for in-line production or repetitive maintenance situations. A range of associated tooling is available to facilitate insert installation, including manual installation tooling and manual, spring and pneumatic operated tang breakoff tools.

Taps and Gauges

Optimum results can be achieved with Recoils range of taps and gauges to suit hand tapping through to volume production requirements. Using the "Go - NoGo" gauge, tapped holes can be gauged to enable a precision fit.



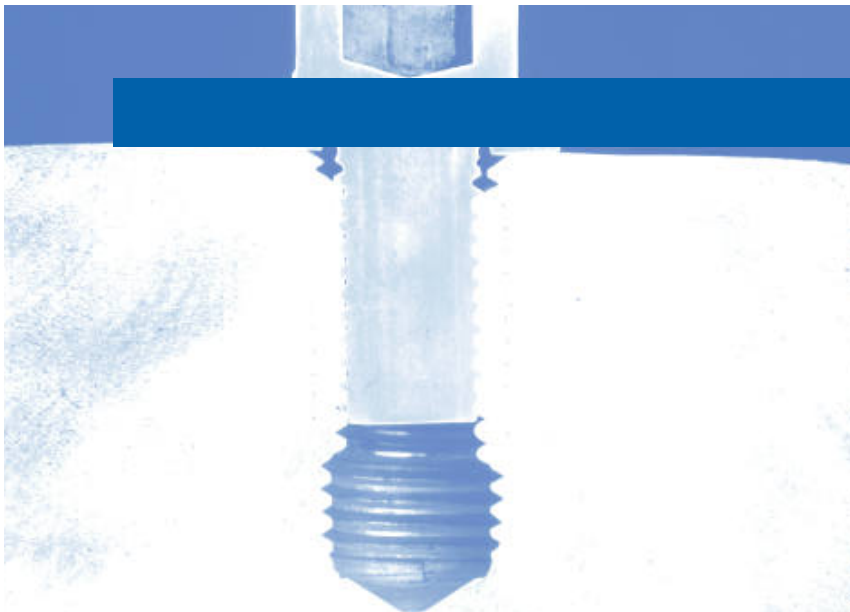

How Does a Recoil Insert Work

Recoil inserts are rolled from high quality stainless steel wire with a diamond shaped cross section, wound to the shape of a spring thread. Once the wire is wound into a helical coil and installed into a tapped hole, it provides a permanent and wear resistant thread in the parent material that is generally stronger than the original thread. The inserts are designed to be greater in diameter than the tapped hole and compress as they are installed. This allows maximum surface contact area with the tapped thread, safely and permanently anchoring the inserts into place. The inserts compensatory action shares the load over the entire bolt and hole increasing holding or pull out strength. With a Recoil insert in place, load and stress are more evenly distributed.

Where to use Recoil Inserts

Repair

When you encounter a damaged thread Recoil offers:

- Quickest and simplest method of repair to stripped or damaged threads
- A superior thread with great holding power
- Most cost effective method of repair
- Returns thread to the original size
- Generally stronger than the original female thread

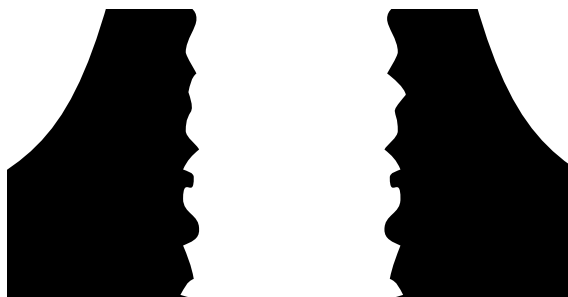

Damaged Thread

Original Equipment Manufacture

Recoil offers innovative manufacturer's the opportunity to design high quality product using lighter weight materials such as Aluminum and Magnesium alloys as well as carbon fibre materials while still achieving high strength and reliability in the threaded fastener assembly. Recoil inserts are widely used by manufacturers in:

- Automotive
- Electronic
- Aerospace
- Ship Building
- Defence
- Power Generation
- Transport
- Manufacturing Equipment

Insert Material

Recoil inserts are generally manufactured from Type 304 stainless steel (18-8), however inserts are available in a range of materials for special applications.

- Stainless Steel Grade 304 (AS7254)
Austenitic Corrosion Resistant Steel
For normal applications up to 425°C (800°F)
- Stainless Steel Grade 316 (AISI 316)
Austenitic Corrosion Resistant Steel
For Marine applications up to 425°C (800°F)
- Inconel X - **750** (AS7246) Nickel Alloy.
For high temperature applications 425°C - 550°C (800°F - 1000°F) or where low permeability is required.
- Phosphor Bronze (DIN 17677 or BS2783 PB 102) (300°C)
For electrical bonding joints or low permeability
- Nimonic 90 (HR 503) for high temperature applications. (650°C)
- Special purpose
Materials such as Inconel 625 and Spring Steel Grade are also available to special order

Type

There are two basic types of Recoil inserts available:

- **Free running** inserts which provide a standard female thread
- **Locking inserts** which provide a locking function for the female thread when the fastener is installed.

Pitch and Angle Error Compensation

Problems

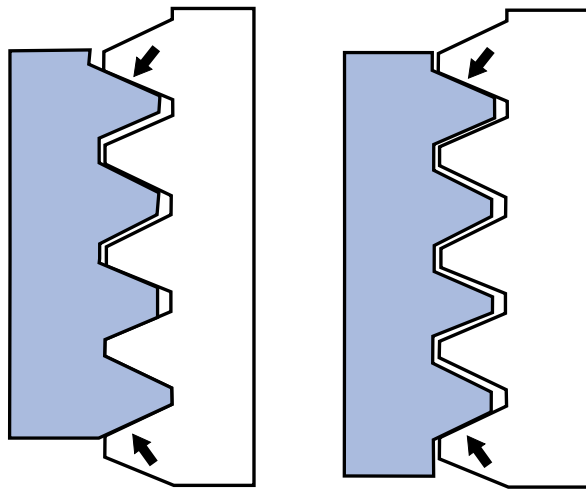

Angle error

Pitch error

Typical thread and angle errors may cause:

- Limited contact point
- Poor flank contact between bolt to parent thread
- Unequal distribution of bolt load over engaged threads
- Failure of threaded components when loaded

Solution

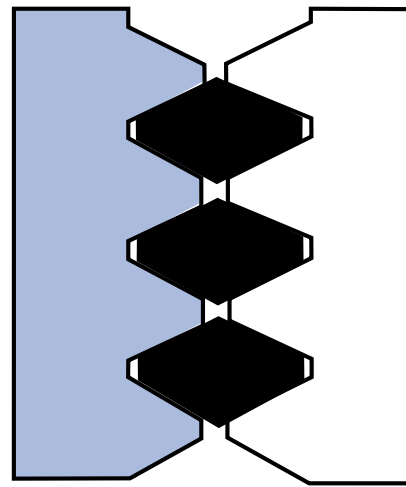

Recoil compensation effect

Recoil inserts reduce thread pitch and angle errors to provide:

- Greater fastener strength
- Greater contact area
- Equally distributed load over all tapped threads
- Reduced stress concentration thereby extending fatigue life

Insert installation and retention

Uninstalled, Recoil inserts are greater in diameter than the tapped hole in the parent material into which they are to be installed. During the assembly operation the diameter of the leading coil is reduced thereby permitting entry of the insert into the tapped hole. When the insert is installed at the correct depth, the coils expand and permanently retains the insert in place.

Unlike many 'solid' insert types, it is not necessary to use locking, swaging or keying operations to locate and retain Recoil inserts. Stress concentration problems which typically occur in the parent material when using solid inserts are therefore eliminated.

A Recoil insert will dimensionally adjust both radially and axially, to any expansion or contraction within the parent material.

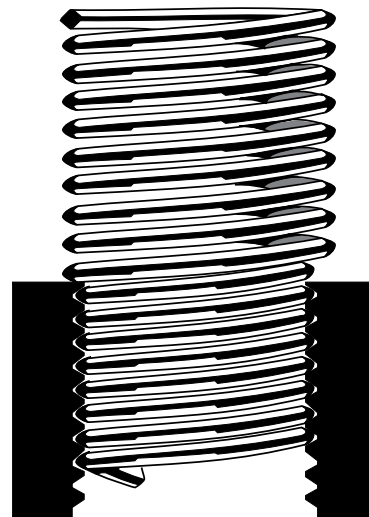

Recoil Insert in "Semi Installed" position.

How Recoil Inserts Work

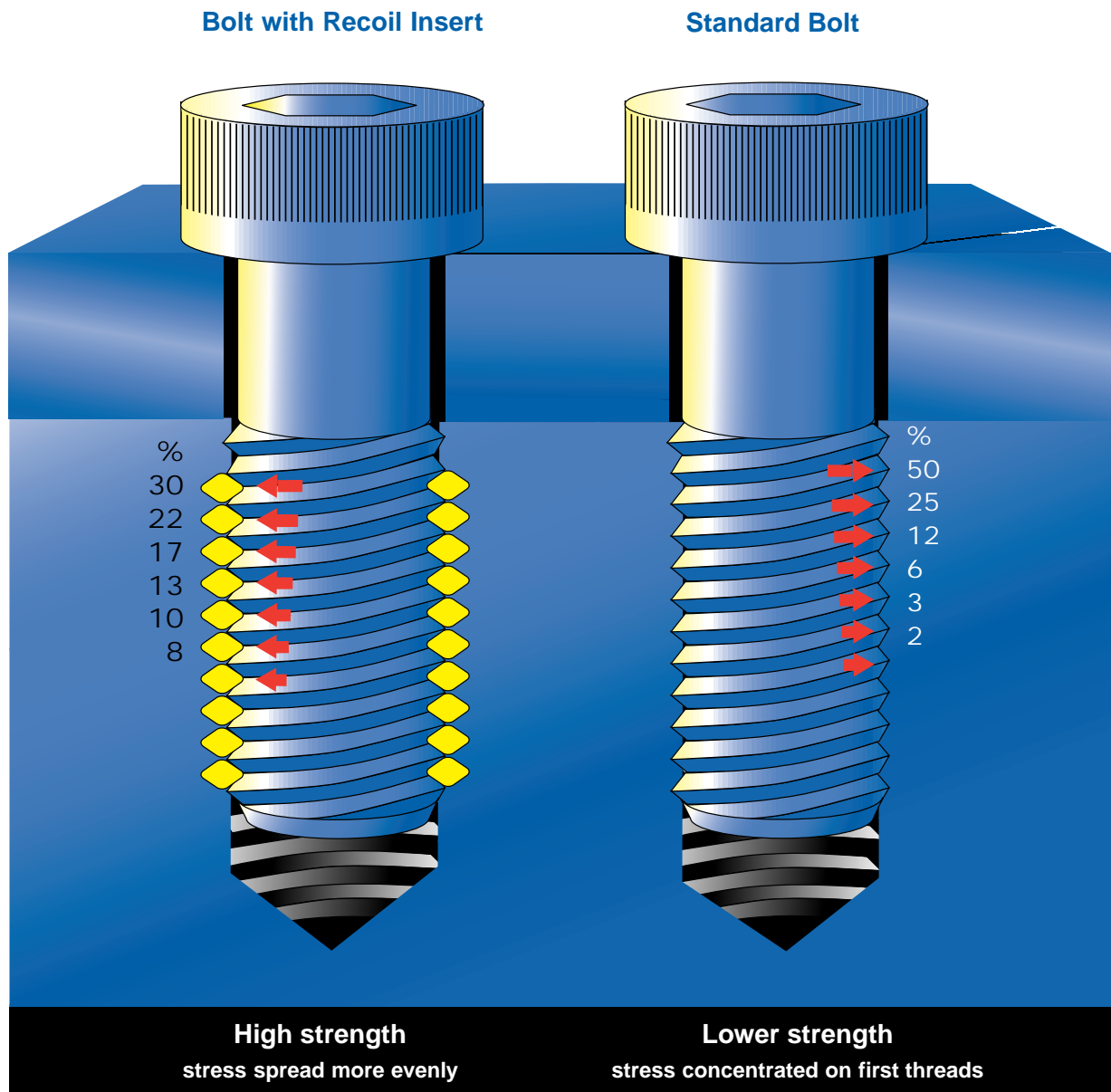

The diagram above depicts graphically the advantages a Recoil insert has over a conventional thread. In conventional threaded joints over 75% of the load is placed on the first three threads of the assembly. The Recoil insert on the left shows how the spring like design of the insert allows the shear loading to be transformed into a preferable "Hoop Stress" or radial loading over the entire length of the insert. This provides a much stronger thread than can be obtained by conventional drilling or tapping. This improved strength allows designers to select a fastener based on the minimum strength of the bolt, also allowing them to select smaller diameters and shorter thread lengths confidently even in low strength materials such as Magnesium or Aluminium alloys. (Refer to design considerations)



How Locking Inserts Work:

The Recoil screw-locking insert is designed to provide a screw-locking feature which will retain screws or bolts under the most severe vibration or varying temperature conditions.

The insert locking configuration comprises of a series of uniquely designed locking chords which, upon the engagement of a screw or bolt, deflect radially, sufficiently enough to permit the installation of the bolt. Upon bolt entry, these straight segments are flexed outwardly, creating pressure on the bolt. This pressure is applied between the flanks of the bolt thread so that contact area is maximised. Locking inserts retain locking torque over numerous assembly cycles. Refer to relevant specifications for insert life.

Each Recoil 'screw-locking' insert type has a specifically designed locking configuration. This ensures that the insert meets its design specification requirements. Therefore the shape, depth and number of locking chords will inevitably vary for differing thread types and sizes.

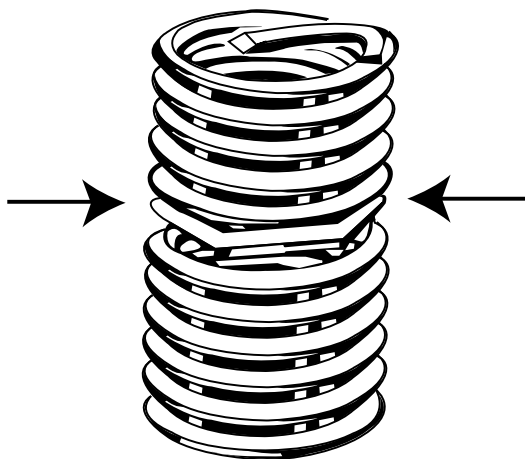

Note: It is recommended that a cadmium plated or dry-film lubricated screw/bolt is used for screw-locking inserts applications. (See page 9 - Lubricants and Coatings)

Locking Insert Design

Should a specific locking torque or function be required, Recoil engineers can develop parts to suit customers needs. As the bolt is wound through the locking chords of the insert it deflects the wire as shown by the internal arrows (A). This deflection causes the insert to push against the bolt resulting in a repeatable locking function from the insert.

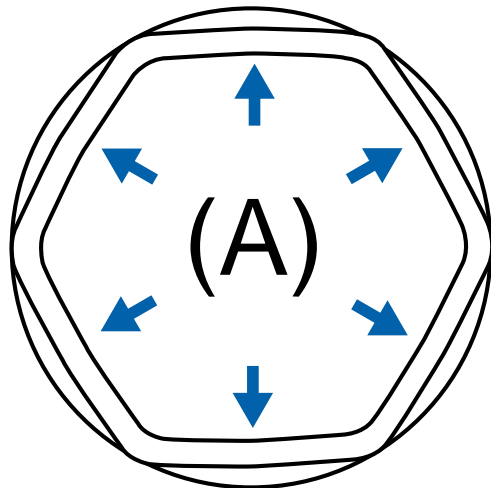

Note: Installation of the Recoil Screw Locking inserts require use of the Recoil Prewinder tooling. (Refer page 25 - Tooling)

Locking Insert Torque Values

Locking torque values for unified inserts conform to MIL - I - 8846. These locking torque values are shown below.

Unified Coarse (UNC)

NOMINAL THREAD SIZE	Max Locking Torque	Min Locking Torque
2 (.086") - 56	20 oz.in	3 oz.in
3 (.099") - 40	32 oz.in	7 oz.in
4 (.112") - 40	48 oz.in	10 oz.in
5 (.125") - 40	75 oz.in	13 oz.in
6 (.138") - 32	6 lb.in	1.0 lb.in
8 (.164") - 32	9 lb.in	1.5 lb.in
10 (.190") - 24	13 lb.in	2.0 lb.in
12 (.216") - 24	24 lb.in	3.0 lb.in
1/4 (.250") - 20	30 lb.in	4.5 lb.in
5/16 (.3125") - 18	60 lb.in	7.5 lb.in
3/8 (.3750") - 18	80 lb.in	12.0 lb.in
7/16 (.4375") - 14	100 lb.in	16.5 lb.in
1/2 (.5000") - 13	150 lb.in	24.0 lb.in
9/16 (.5625") - 12	200 lb.in	30.0 lb.in
5/8 (.6250") - 11	300 lb.in	40.0 lb.in
3/4 (.7500") - 10	400 lb.in	60.0 lb.in
7/8 (.8750") - 9	600 lb.in	82.0 lb.in
1 (1.000") - 8	800 lb.in	110.0 lb.in
1 1/8 (1.1250") - 7	900 lb.in	137.0 lb.in
1 1/4 (1.1250") - 7	1000 lb.in	165.0 lb.in
1 3/8 (1.3750") - 6	1150 lb.in	185.0 lb.in
1 1/2 (1.5000") - 6	1350 lb.in	210.0 lb.in

Unified Fine (UNF)

NOMINAL THREAD SIZE	Max Locking Torque	Min Locking Torque
3 (.099) - 56	32 oz.in	7oz.in
4 (.112) - 48	48 oz.in	10 oz.in
6 (.138) - 40	6 lb.in	1.0 lb.in
8 (.164) - 36	9 lb.in	1.5 lb.in
10 (.190) - 32	13lb.in	2.0 lb.in
1/4 (.2500) - 28	30 lb.in	3.5 lb.in
5/16 (.3125) - 24	60 lb.in	6.5 lb.in
3/8 (.3750) - 24	80 lb.in	9.5 lb.in
7/16 (.4375) -20	100 lb.in	14.0 lb.in
1/2 (.5000) - 20	150 lb.in	18.0 lb.in
9/16 (.5625) - 18	200 lb.in	24.0 lb.in
5/8 (.6250) - 18	300 lb.in	32.0 lb.in
3/4 (.7500) - 16	400 lb.in	50.0 lb.in
7/8 (.8750) - 14	600 lb.in	70.0 lb.in
1 (1.0000) - 12	800 lb.in	90.0 lb.in
1 1/8 (1.1250) - 12	900 lb.in	117.0 lb.in
1 1/4 (1.2500) - 12	1000 lb.in	143.0 lb.in
1 3/8 (1.3750) - 12	1150 lb.in	165.0 lb.in
1 1/2 (1.5000) -12	1350 lb.in	190.0 lb.in

Metric Coarse Series

NOMINAL THREAD SIZE	Max Locking Torque	Min Locking Torque
M2.2 x 0.45	0.14 Nm	0.02 Nm
M2.5 x 0.45	0.23 Nm	0.05 Nm
M3 x 0.5	0.45 Nm	0.1 Nm
M3.5 x 0.6	0.68 Nm	0.12 Nm
M4 x 0.7	0.9 Nm	0.15 Nm
M5 x 0.8	1.6 Nm	0.3 Nm
M6 x 1	3 Nm	0.4 Nm
M7 x 1	4.5 Nm	0.6 Nm
M8 x 1.25	6 Nm	0.8 Nm
M10 x 1.5	10.5 Nm	1.4 Nm
M12 x 1.75	15.5 Nm	2.1Nm
M14 x 2	23.5 Nm	3 Nm
M16 x 2	31.5 Nm	4.2 Nm
M18 x 2.5	42 Nm	5.5 Nm
M20 x 2.5	54 Nm	7 Nm
M22 x 2.5	67.5 Nm	9 Nm
M24 x 3	80 Nm	10.5 Nm
M27 x 3	94 Nm	12 Nm
M30 x 3.5	108 Nm	14 Nm
M33 x 3.5	122 Nm	15.5 Nm
M36 x 4	136 Nm	17.5 Nm
M39 x 4	150 Nm	19.5 Nm

Metric Fine Series

NOMINAL THREAD SIZE	Max Locking Torque	Min Locking Torque
M8 x 1	6 Nm	0.8 Nm
M10 x 1	10.5 Nm	1.4 Nm
M10 x 1.25	10.5 Nm	1.4 Nm
M12 x 1.25	15.5 Nm	2.1 Nm
M12 x 1.5	15.5 Nm	2.1 Nm
M14 x 1.5	23.5 Nm	3 Nm
M16 x 1.5	31.5 Nm	4.2 Nm
M18 x 1.5	42 Nm	5.5 Nm
M20 x 1.5	54 Nm	7 Nm
M22 x 1.5	67.5 Nm	9 Nm
M18 x 2	42 Nm	5.5 Nm
M20 x 2	54 Nm	7 Nm
M22 x 2	67.5 Nm	9 Nm
M24 x 2	80 Nm	10.5 Nm
M27 x 2	94 Nm	12 Nm
M30 x 2	108 Nm	14 Nm
M33 x 2	122 Nm	15.5 Nm
M36 x 2	136 Nm	17.5 Nm
M39 x 2	150 Nm	19.5 Nm
M36 x 3	136 Nm	17.5 Nm
M39 x 3	150 Nm	19.5 Nm

Locking torque values for Metric Recoil inserts conform to MA3329, MA3330 and MA3331. These locking torque limits are shown above.

Note: Unplated, heat-treated screws or stainless steel screws should not be used with screw-lock inserts. An anti-seize compound (Molybdenum Disulphide, etc) should be applied to the screw to minimise galling and achieve maximum cycle life. Also available are inserts plated with cadmium per QQ-P-416, Type II, or dry film lubricant per MIL-L-8937 (no graphite) which improves wear life of the screw and insert.

Note: It is imperative that the bolts fully engage all locking coils for correct torque and all insert coils for maximum strength.

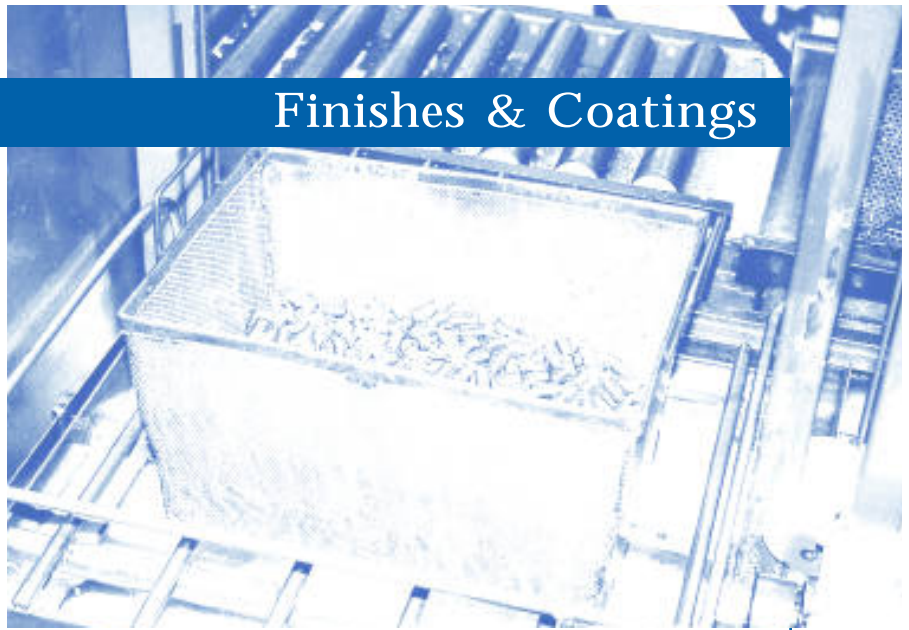

Lubricants and Coatings

It is important that correct selection of the most suitable fastening lubricant or coating is made at the design stage for long term security within the bolted joint.

The ideal finish or coating for the insert is dependent upon the optimum coefficient of friction (governed by the bolt material and surface finish), and the required service conditions of the assembled parts, e.g. temperature, chemical influences, humidity and dust.

The coefficient of friction (μ) of most threaded components will generally vary between $\mu = 0.15$ and $\mu = 0.35$.

For example differences occur between bolts made of Grade 8.8 steel (Werkstoff 1.0503), compared with the same size of bolt, but produced from an austenitic stainless steel X5 CrNi 18-9, (Werkstoff 1.4301).

Differences also occur between bolts having different surface coatings, such as electro-galvanising, hot galvanising, cadmium plating or chromium plating.

Typical Recoil wire thread insert finishes and coatings

PLATING / FINISH	PART NUMBER SUFFIX	APPLICABLE PROCESS SPECIFICATION
Silver Plating	AG	QQS-365 or AMS2411 or EN2786
Cadmium plating	C	QQP-416 or DEF STD 03-19
Dry Film Lubricant	D	MIL-L-8937 or MIL-L-46010
Red Dye	Not Applicable	Applied to all Recoil locking inserts for identification where called for by specification*

* Recoil inserts may also be dyed in other colours such as Green and Blue for identification purposes.

MATERIAL TYPE	MAX. TEMPERATURE		TYPICAL APPLICATIONS	COATINGS (SEE SECTION ON LUBRICANTS)
	PEAK	CONTINUOUS		
Stainless 304	425°C (800°F)	315°C (600°F)	Most general applications in all materials	Non-finished Dry film Lubricant Silver Cadmium
Stainless 316	425°C (800°F)	315°C (600°F)	Improved corrosion resistance Salt water applications	Non-finished Dry film Lubricant Silver Cadmium
Phosphor Bronze	300°C (572°F)	235°C (455°F)	Copper parts Non magnetic / Low permeability applications	Cadmium Silver
Inconel x 750	650°C (1200°F)	550°C (1020°F)	Aerospace / Turbines / Corrosive atmospheres / High temperature use	Silver Copper
Nimonic alloy 90	650°C (1200°F)	550°C (1020°F)	Aerospace / Turbine applications	Silver

Silver Plating

Primarily used to reduce the effects of galling (seizure) of screw threads in high temperature service applications.

Silver plating is the most commonly used coating for aero-engine fasteners providing an even degree of lubrication up to a maximum service temperature of about 650°C (1200°F).

The plated silver is electrolytically deposited in typical thicknesses up to 6.3µm (0.00025").

Silver plated wire thread inserts may be installed into various housing materials including magnesium alloys, aluminium alloys, corrosion and heat resistant materials, etc.

Caution must be emphasised where inserts are to be installed into titanium alloy components which may exceed a service temperature of 300°C (570°F). Silver plated inserts are not recommended with titanium housings as stress corrosion, resulting from the combination of silver with titanium may occur in the housing material.

Cadmium Plating

In mildly corrosive or marine environments, cadmium plating is the preferred treatment for providing protection against pitting of the insert/bolt materials and to minimise the risk of thread seizure.

Plating thickness may vary depending on particular applications, between 2µm - 5µm (0.0001" - 0.0002"). Following cadmium plating, either a bronze or olive drab chromate finish will be used to provide uniformity in the overall finish.

It should be noted that cadmium plated parts must not:-

- Be subjected to temperatures exceeding 235°C (455°F).
- Come into contact with fuel or hot oil.
- Come into contact with food or drinking water
- Be used with titanium components either directly or indirectly as, at elevated temperatures, embrittlement and subsequent component failure may occur.

Warning: Cadmium is a highly toxic compound. Because of its poisonous nature extreme care must be taken when handling.

Dry Film Lubricants

Used for mildly corrosive or high temperature applications, dry film lubricants comprise of suspensions of small particles of solid lubricants such as molybdenum disulphide (MoS₂) or PTFE, in organic or inorganic binders. They are applied as a thin film (5µm - 20µm) to grease-free metal surfaces.

Through careful selection of appropriate additives and solvents, specific lubricants may be formulated to suit most industrial applications to service temperatures around 315°C (600°F).

Special high temperature lubricant coatings are available for use up to 425°C (800°F).

Recoil inserts may be coated with dry-film lubricant in either the non-finished (passivated) condition or after cadmium plating treatment for maximum corrosion protection.

Red Dye Coating

Recoil screw-locking inserts are, generally colour coded with a red dye coating for identification purposes only. This organic resin based dye does not affect the installation or function of the inserts and normally does not need to be removed.

However, if in extreme conditions of cleanliness (such as precision instrument assembly in clean room conditions) removal of the dye may be desired.

The red dye may be removed by soaking the inserts in a denatured alcohol solution prior to use.

To prevent galling or seizing when using an unplated or corrosion resistant screw/bolt in a screw-locking insert, we recommend the use of an anti-seize compound on the bolt threads.

Corrosion Protection

Under some service conditions, Recoil inserts and their mating parts may be subjected to a degree of corrosion, the severity of which is dependent upon the particular application.

Factors such as: differing material types, atmospheric conditions, chemical attack and even frequency of use will have an appreciable effect on the longevity of the bolted joint.

The following are recommendations to minimise corrosion within the bolted Recoil insert assemblies:-

Normal Service: Natural atmospheric environment with the screw/bolt permanently installed into the insert not adjacent to salt water.

Severe Service: Mildly contaminated atmospheric environments involving moisture, occasional exposure to a chloride air or sea spray and where the screw/bolt may be removed from the insert for extended periods of time.

Extreme Severe Service: Assembly is exposed to salt water, corrosive atmosphere, high temperature or the screw/bolt is frequently removed from the assembly, allowing the ingress of water into a blind hole.

In addition to methods 1, 2 and 3 below, further corrosion protection can be achieved by:-

- Using blind holes wherever possible
- Using a sealing, insulating or step-down type washer under the head of the bolt.
- Using bolts that extend completely through the entire length of the insert.
- In critical applications, the use of a non-hardening seal or compound over the joint and protecting bolt thread is recommended.

Note - For extremely severe service conditions involving temperatures in excess of 425°C (800°F), or contact with acids, alkalis or sea water stainless steel inserts are not recommended.

Corrosion Protection Methods

PARENT MATERIAL	SERVICE CONDITIONS		
	NORMAL	SEVERE	EXTREME SEVERE
Aluminium	None	Methods 2 or 3	Methods 1,2 & 3
Magnesium	Methods 2 or 3	Methods 2 and 3	Methods 1, 2 & 3

Typical Corrosion Recommendations

METHOD 1	METHOD 2	METHOD 3
Parent Material Protection Aluminium: For oxide coating use Alodine, Anodise, Iridite, or similar. Iridite 14 or 14-2 (MIL-C-554) is recommended for critical parts rather than anodising (MIL-S-5002)	Coat the insert with one of the following: Cadmium per QQ-P-416, Type II 0.0001" thick; or Dry Film Lubricant per MIL- L- 893 (must be free of graphite)	Separate the parent material from the insert by using liquid zinc chromate primer, Federal Specification TT-P-1757 Apply the primer to the hole sparingly and install while the primer is still wet.

Gas and Water Applications

Where gas or water threads are being manufactured or repaired it is important that a Recoil sales office be consulted regarding the type of seal that will be provided in this situation. A wire insert may not provide a satisfactory thread seal.

MS Insert Dimensional Data

Drawing Call-Out

An example of a typical drawing specification for a Recoil insert is shown below:

Free coil diameter
.448"
.468"

No. of coil = 11

End of coil may be square or angular

Vee notch on top or side face of first coil

1. Recoil insert part number 14063.
2. Size and Location of notch, shape of tang, reduced first coil & all dimensions not shown will be produced to Recoil standards.
3. Number of free coils to be counted from the notch.

NAME	MATERIAL STAINLESS STEEL AS 7245	DESCRIPTION INSERT 3/8"-24X1 1/2"D .562" LONG ST. STL
NAME	PART No.	MANUFACTURER RECOIL PTY

A typical drawing call-out for a Recoil screw-locking insert 3/8" - 24 x 11/2 dia. long Class 3B Unified Fine Thread (UNF) is shown.

Drawing call-outs can be simply defined by using a production sequence process sheet to provide the operational steps with the drawing showing dimensional limits and data. (Example shown below)

- 1) Drill hole $25/64"$ (.3906") diameter, depth .812" plus your normal standard for drilling depth.
- 2) Countersink $120^\circ \pm 5^\circ$.42"/.45" diameter.
- 3) Tap with Recoil STI Tap No. 44065 (class 3B) full thread depth .600".
- 4) Gauge with Recoil Gauge No. 64063 or according to your inspection requirements.
- 5) Install Recoil screw-lock insert 14063 with Recoil Inserting Tool No. 54061.
- 6) Break off driving tang with Recoil Tang Break-off Tool No. 59280.

Recoil Thread Insert Part Numbering System

Recoil insert product part numbering system uses a logically structured 5 digit basic part number. Suffixes are typically added to differentiate between special or non-standard features.

This guide defines the structure of Recoils part numbers and may be used for reference to identify a Recoil insert from its part number.

Recoil Insert Part Number Example

O5082XAG

First Digit = Category

- 0=Inserts Bulk - Free Running
- 1=Inserts Bulk - Self Locking
- 2=Insert Packets (Free running only)

Fifth Digit = Insert

Length in 1/2 Diameters

- 2=1D
- 3=1.5D
- 4=2D
- 5=2.5D
- 6=3D

Special Suffixes

- AG=Silver plated
- C=Cadmium plated
- D=Dry Film Lubrication
- LH=Left Hand
- PB=Phosphor Bronze
- SF=Strip Feed
- X=Inconel X750
- Y=316 Stainless Steel

Second Digit = Thread Diameter

- 0=BSP, BA
- 1=BSP
- 2=BSW
- 3=UNC
- 4=UNF, UNEF, UNS, ETC.
- 5=METRIC Coarse
- 6=NPT, BSC, 8UN
- 7=Metric Fine
- 8=Metric Fine & Spark-Plug

Third and Fourth Digit = Thread Diameter

- 0=size in 1/16"s (ie 08=1/2")
- 1=size in 1/16"s (ie 08=1/2")
- 2=size in 1/16"s (ie 08=1/2")
- 3=size in 1/16"s (ie 08=1/2")
- 4=size in 1/16"s (ie 08=1/2")
- 5=size in 1mm's (ie 08=8mm)
- 6=size in 1/16"s (ie 08=1/2")
- 7=size in 1mm's (ie 08=8mm)
- 8=size in 1mm's (ie 08=8mm)

Example - O5082-XAG =M8 - 1.25 x1D Inconel X750, silver plated insert

Inch Series Insert Dimensional Data

Recoil Inch Insert Part Number Call-Out and Dimensional Data

THREAD SIZE	PART # - STANDARD INSERT NOMINAL LENGTH					PART # - LOCKING INSERT NOMINAL LENGTH					FREE COIL DIAMETER		NUMBER OF COILS NOMINAL LENGTH				
	1D	1½D	2D	2½D	3D	1D	1½D	2D	2½D	3D	MIN	MAX	1D	1½D	2D	2½D	3D
INCH SERIES - COARSE THREAD																	
2 (.086) - 56	03522	03523	03524	03525	03526	13522	13523	13524	13525	13526	.110	.119	3.000	5.250	7.375	9.625	11.875
3 (.099) - 48	03532	03533	03534	03535	03536	13532	13533	13534	13535	13536	.128	.139	2.875	5.000	7.250	9.375	11.500
4 (.112) - 40	03542	03543	03544	03545	03546	13542	13543	13544	13545	13546	.144	.159	2.750	4.750	6.750	8.875	10.875
5 (.125) - 40	03552	03553	03554	03555	03556	13552	13553	13554	13555	13556	.158	.173	3.250	5.500	7.750	10.000	12.250
6 (.138) - 32	03562	03563	03564	03565	03566	13562	13563	13564	13565	13566	.178	.193	2.750	4.750	6.875	8.875	10.750
8 (.164) - 32	03582	03583	03584	03585	03586	13582	13583	13584	13585	13586	.205	.220	3.500	6.000	8.375	10.750	13.250
10 (.190) - 24	03602	03603	03604	03605	03606	13602	13603	13604	13605	13606	.244	.259	2.875	5.000	7.125	9.250	11.375
12 (.216) - 24	03622	03623	03624	03625	03626	13622	13623	13624	13625	13626	.270	.285	3.500	6.000	8.375	10.625	13.125
1/4 (.2500) - 20	03042	03043	03044	03045	03046	13042	13043	13044	13045	13046	.310	.330	3.375	5.750	8.000	10.375	12.750
5/16 (.3125) - 18	03052	03053	03054	03055	03056	13052	13053	13054	13055	13056	.380	.400	4.000	6.625	9.250	11.875	14.625
3/8 (.3750) - 16	03062	03063	03064	03065	03066	13062	13063	13064	13065	13066	.452	.472	4.375	7.250	10.000	12.875	15.750
7/16 (.4375) - 14	03072	03073	03074	03075	03076	13072	13073	13074	13075	13076	.526	.551	4.500	7.375	10.250	13.125	16.125
1/2 (.5000) - 13	03082	03083	03084	03085	03086	13082	13083	13084	13085	13086	.597	.622	4.875	7.875	11.000	14.125	17.125
9/16 (.5625) - 12	03092	03093	03094	03095	03096	13092	13093	13094	13095	13096	.669	.694	5.125	8.250	11.500	14.750	17.125
5/8 (.6250) - 11	03102	03103	03104	03105	03106	13102	13103	13104	13105	13106	.742	.767	5.250	8.500	11.750	15.000	18.375
3/4 (.7500) - 10	03122	03123	03124	03125	03126	13122	13123	13124	13125	13126	.881	.906	5.875	9.375	13.000	16.500	20.125
7/8 (.8750) - 9	03142	03143	03144	03145	03146	13142	13143	13144	13145	13146	1.022	1.052	6.250	10.000	13.750	17.500	21.250
1 (1.0000) - 8	03162	03163	03164	03165	03166	13162	13163	13164	13165	13166	1.166	1.196	6.375	10.125	14.000	17.750	21.625
1 1/8 (1.1250) - 7	03182	03183	03184	03185	03186	13182	13183	13184	13185	13186	1.315	1.355	6.125	9.875	13.625	17.500	21.250
1 1/4 (1.2500) - 7	03202	03203	03204	03205	03206	13202	13203	13204	13205	13206	1.443	1.483	7.000	11.250	15.375	19.500	23.750
1 3/8 (1.3750) - 6	03222	03223	03224	03225	03226	13222	13223	13224	13225	13226	1.598	1.643	6.500	10.500	14.375	18.375	22.250
1 1/2 (1.5000) - 6	03242	03243	03244	03245	03246	13242	13243	13244	13245	13246	1.727	1.772	7.250	11.500	15.875	20.125	24.500
INCH SERIES - FINE THREAD																	
3 (.099) - 56	04532	04533	04534	04535	04536	14532	14533	14534	14535	14536	.131	.146	3.375	5.625	8.000	10.375	12.625
4 (.112) - 48	04542	04543	04544	04545	04546	14542	14543	14544	14545	14546	.147	.162	3.375	5.625	7.875	10.250	12.500
6 (.138) - 40	04562	04563	04564	04565	04566	14562	14563	14564	14565	14566	.173	.193	3.500	6.000	8.375	10.750	13.250
8 (.164) - 36	04582	04583	04584	04585	04586	14582	14583	14584	14585	14586	.204	.224	3.875	6.500	9.125	11.625	14.250
10 (.190) - 32	04602	04603	04604	04605	04606	14602	14603	14604	14605	14606	.236	.256	4.125	6.875	9.500	12.000	14.875
1/4 (.2500) - 28	04042	04043	04044	04045	04046	14042	14043	14044	14045	14046	.306	.326	5.000	8.250	11.375	14.500	17.625
5/16 (.3125) - 24	04052	04053	04054	04055	04056	14052	14053	14054	14055	14056	.380	.400	5.500	8.875	12.250	15.625	19.000
3/8 (.3750) - 24	04062	04063	04064	04065	04066	14062	14063	14064	14065	14066	.448	.468	6.875	11.000	15.000	19.125	23.125
7/16 (.4375) - 20	04072	04073	04074	04075	04076	14072	14073	14074	14075	14076	.524	.549	6.625	10.625	14.625	18.500	22.500
1/2 (.5000) - 20	04082	04083	04084	04085	04086	14082	14083	14084	14085	14086	.592	.617	7.875	12.375	16.875	21.375	25.875
9/16 (.5625) - 18	04092	04093	04094	04095	04096	14092	14093	14094	14095	14096	.666	.691	8.000	12.500	17.125	21.750	26.250
5/8 (.6250) - 18	04102	04103	04104	04105	04106	14102	14103	14104	14105	14106	.733	.758	9.000	14.125	19.250	24.250	29.375
3/4 (.7500) - 16	04122	04123	04124	04125	04126	14122	14123	14124	14125	14126	.876	.901	9.750	15.125	20.625	26.000	31.500
7/8 (.8750) - 14	04142	04143	04144	04145	04146	14142	14143	14144	14145	14146	1.021	1.051	9.875	15.500	21.125	26.625	32.250
1 (1.0000) - 14	04162-14	04163-14	04164-14	04165-14	04166-14	14162-14	14163-14	1464-14	14165-14	14166-14	1.156	1.186	11.500	17.875	24.250	30.625	37.000
1 (1.0000) - 12	04162	04163	04164	04165	04166	04162	14163	14164	14165	14166	1.169	1.199	9.625	15.000	20.500	26.000	31.500
1 1/8 (1.1250) - 12	04182	04183	04184	04185	04186	14182	14183	14184	14185	14186	1.304	1.334	11.125	17.250	23.375	29.500	35.750
1 1/4 (1.2500) - 12	04202	04203	04204	04205	04206	14202	14203	14204	14205	14206	1.439	1.469	12.500	19.375	26.250	33.000	39.875
1 3/8 (1.3750) - 12	04222	04223	04224	04225	04226	14222	14223	14224	14225	14226	1.575	1.610	13.750	21.375	28.875	36.500	44.000
1 1/2 (1.5000) - 12	04242	04243	04244	04245	04246	14242	14243	14244	14245	14246	1.710	1.745	15.250	23.500	31.625	39.875	48.125

Note: Dimensions apply to MIL specification parts only.

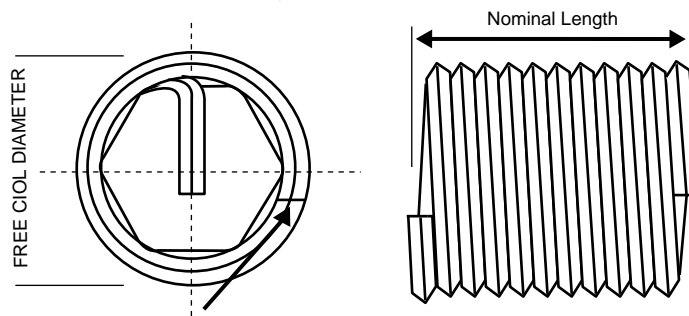

Metric Series Insert Dimensional Data

Recoil Metric Insert Part Number Call-Out and Dimensional Data

THREAD SIZE	PART # - STANDARD INSERT NOMINAL LENGTH					PART # - LOCKING INSERT NOMINAL LENGTH					FREE COIL DIAMETER		NUMBER OF COILS NOMINAL LENGTH				
	1D	1½D	2D	2½D	3D	1D	1½D	2D	2½D	3D	MIN	MAX	1D	1½D	2D	2½D	3D
METRIC SERIES - COARSE THREAD																	
M2.2 x 0.45	05012	05013	05014	05015	05016	15012	15013	15014	15015	15016	2.80	3.00	3.125	5.375	7.625	9.875	12.125
M2.5 x 0.45	05252	05253	05254	05255	05256	15252	15253	15254	15255	15256	3.20	3.70	3.375	5.750	8.125	10.500	12.750
M3 x 0.5	05032	05033	05034	05035	05036	15032	15033	15034	15035	15036	3.80	4.35	3.750	6.375	8.875	11.375	13.875
M3.5 x 0.6	05352	05353	05354	05355	05356	15352	15353	15354	15355	15356	4.40	4.95	3.750	6.375	8.625	11.375	13.625
M4 x 0.7	05042	05043	05044	05045	05046	15042	15043	15044	15045	15046	5.05	5.60	3.625	6.125	8.625	11.125	13.625
M5 x 0.8	05052	05053	05054	05055	05056	15052	15053	15054	15055	15056	6.25	6.80	4.125	6.875	9.625	12.375	15.125
M6 x 1	05062	05063	05064	05065	05066	15062	15063	15064	15065	15066	7.40	7.95	4.000	6.750	9.500	12.125	14.875
M7 x 1	05072	05073	05074	05075	05076	15072	15073	15074	15075	15076	8.65	9.20	4.875	8.000	11.125	14.125	17.250
M8 x 1.25	05082	05083	05084	05085	05086	15082	15083	15084	15085	15086	9.80	10.35	4.500	7.375	10.250	13.250	16.125
M10 x 1.5	05102	05103	05104	05105	05106	15102	15103	15104	15105	15106	11.95	12.50	4.875	8.000	11.125	14.250	17.375
M12 x 1.75	05122	05123	05124	05125	05126	15122	15123	15124	15125	15126	14.30	15.00	5.000	8.250	11.500	14.625	17.875
M14 x 2	05142	05143	05144	05145	05146	15142	15143	15144	15145	15146	16.65	17.35	5.125	8.500	11.750	15.000	18.375
M16 x 2	05162	05163	05164	05165	05166	15162	15163	15164	15165	15166	18.90	19.60	6.125	9.750	13.500	17.250	21.000
M18 x 2.5	05182	05183	05184	05185	05186	15182	15183	15184	15185	15186	21.30	22.00	5.375	8.875	12.250	15.625	19.000
M20 x 2.5	05202	05203	05204	05205	05206	15202	15203	15204	15205	15206	23.55	24.40	6.125	9.875	13.625	17.375	21.125
M22 x 2.5	05222	05223	05224	05225	05226	15222	15223	15224	15225	15226	25.90	26.90	6.750	10.875	14.875	19.000	23.125
M24 x 3	05242	05243	05244	05245	05246	15242	15243	15244	15245	15246	28.00	29.00	6.125	10.000	13.750	17.500	21.375
M27 x 3	05272	05273	05274	05275	05276	15272	15273	15274	15275	15276	31.40	32.40	7.000	11.250	15.500	19.750	24.000
M30 x 3	05302	05303	05304	05305	05306	15302	15303	15304	15305	15306	34.90	36.10	7.875	12.500	17.125	21.875	26.500
M33 x 3	07332-3	07333-3	07334-3	07335-3	07336-3	17332-3	17333-3	17334-3	17335-3	17336-3	38.10	39.50	8.750	13.875	19.000	24.125	29.250
M36 x 3	07362	07363	07364	07365	07366	17362	17363	17364	17365	17366	41.30	42.70	9.750	15.250	20.875	26.500	32.000
M39 x 3	07392	07393	07394	07395	07396	17392	17393	17394	17395	17396	44.40	45.80	10.750	16.750	22.750	28.875	34.875
METRIC SERIES - FINE THREAD																	
M8 x 1	07082	07083	07084	07085	07086	17082	17083	17084	17085	17086	9.70	10.25	5.875	9.375	13.000	16.500	20.125
M10 x 1.25	07102	07103	07104	07105	07106	17102	17103	17104	17105	17106	12.10	12.65	5.875	9.500	13.125	16.750	20.375
M12 x 1.25	08122	08123	08124	08125	08126	18122	18123	18124	18125	18126	14.30	15.00	7.250	11.625	15.875	20.250	24.500
M12 x 1.5	07122	07123	07124	07125	07126	17122	17123	17124	17125	17126	14.25	14.95	6.000	9.625	13.375	17.000	20.750
M14 x 1.5	07142	07143	07144	07145	07146	17142	17143	17144	17145	17146	16.55	17.25	7.125	11.375	15.625	20.000	24.250
M16 x 1.5	07162	07163	07164	07165	07166	17162	17163	17164	17165	17166	18.90	19.60	8.250	13.125	18.000	22.750	27.625
M18 x 1.5	08182	08183	08184	08185	08186	18182	18183	18184	18185	18186	21.05	21.75	9.500	15.000	20.375	25.875	31.375
M18 x 2	07182	07183	07184	07185	07186	17182	17183	17184	17185	17186	21.15	21.85	7.000	11.125	15.375	19.500	23.625
M20 x 1.5	08202	08203	08204	08205	08206	18202	18203	18204	18205	18206	23.15	24.00	10.750	16.875	22.875	28.875	35.000
M20 x 2	07202	07203	07204	07205	07206	17202	17203	17204	17205	17206	23.20	24.05	7.875	12.500	17.250	21.875	26.500
M22 x 1.5	08222	08223	08224	08225	08226	18222	18223	18224	18225	18226	25.55	26.45	11.875	18.500	25.125	31.625	38.250
M22 x 2	07222	07223	07224	07225	07226	17222	17223	17224	17225	17226	25.60	26.50	8.750	13.750	18.875	23.875	29.000
M24 x 2	07242	07243	07244	07245	07246	17242	17243	17244	17245	17246	28.10	29.10	9.500	15.000	20.375	25.875	31.250
M27 x 2	07272	07273	07274	07275	07276	17272	17273	17274	17275	17276	31.30	32.30	10.875	17.000	23.250	29.375	35.500
M30 x 2	07302	07303	07304	07305	07306	17302	17303	17304	17305	17306	34.50	35.70	12.250	19.125	25.875	32.750	39.500
M33 x 2	07332	07333	07334	07335	07336	17332	17333	17334	17335	17336	37.80	39.20	13.625	21.125	28.625	36.000	43.500
M36 x 2	07362-2	07363-2	07364-2	07365-2	07366-2	17362-2	17363-2	17364-2	17365-2	17366-2	41.00	42.40	15.000	23.250	31.375	39.500	47.750
M39 x 2	08392	08393	08394	08395	08396	18392	18393	18394	18395	18396	44.30	45.70	16.375	25.250	34.125	43.000	51.875

Note: Recoil metric inserts are made to Din locking torque requirements. Military specification MA parts need to be specifically ordered by adding MA to the standard part number above.

Note: Dimensions shown are for MA parts only.

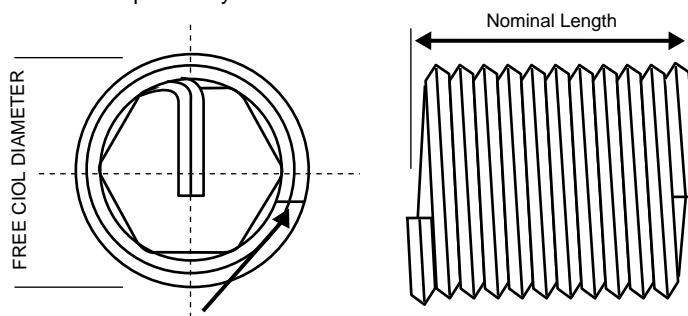



Recoil Insert Taps

Recoil taps differ from standard taps dimensionally and only Recoil Screw Thread Insert (STI) Taps are suitable for use with Recoil Wire Thread Inserts.

Recoil taps are manufactured to precise standards from either High Speed Steel (HSS) or (HSS-E) with ground threads and are available with taper, intermediate and bottoming leads. They have a larger diameter, but the same pitch as a standard tap in order to accommodate the wire insert.

Spiral point and spiral flute machine taps are also available for volume production purposes. For all sparkplug applications, pilot nose taps are recommended and are available for common metric thread sizes.

The Recoil thread insert when installed into a correctly tapped hole will provide the applicable internal thread tolerance for the installed bolt.

Note: Tapped hole size can be significantly affected by variations in drill size, parent material, or lubricant so in close tolerance applications some testing for an optimum combination is recommended.

Thread Class

Unified Thread Class

In the unified thread system, the minimum pitch diameter for a 2B hole (medium fit) or 3B hole (close fit) are the same, while the maximum pitch diameter is greater on the 2B hole (medium fit). Recoil taps for unified threads are made to a 3B hole (close fit) tolerance.

Metric Thread Class

In the metric thread system the minimum pitch diameter for a 5H hole (medium fit) or 4H5H hole (close fit) are the same, while the maximum pitch diameter is greater on the 5H hole (medium fit). Recoil taps for metric threads are made to 4H5H hole (close fit) tolerance.

Metric thread tolerance equivalents standards

	Standards	Recoil Standards
Medium	Metric 6H	5H
Close	Metric 5H	4H5H

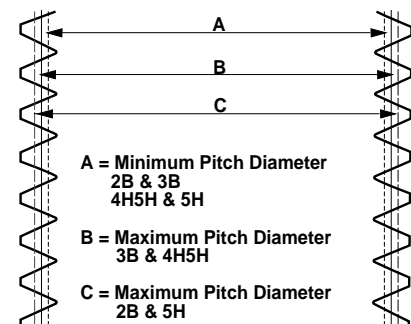

Minimum & Maximum pitch diameter

Tap Type and Applications

The most commonly used type of Recoil taps are defined together with their typical applications. The Taper, Intermediate and Bottoming are short machine taps (suitable for hand tapping), while the Spiral Point and Spiral Flute are used in production applications.

Taper

Taper (or Roughing Taps) are used for starting precision and difficult holes. This tap has a lead of eight threads, but no size reduction.



Intermediate

Intermediate (or Plug/Second), used in most general purpose applications to facilitate thread cutting true to the drilled hole. The tap has a lead of four threads, but no size reduction.



Bottoming

Bottoming Taps are used to ensure the minimum thread run-out when tapping to the bottom of blind holes. The tap has a lead of two threads and would normally be preceded by a taper or an intermediate tap.



Pilot Nose

Pilot nose Taps have been developed for repairing damaged threads without the need for drilling prior to tapping. This style of tap allows the use of the existing thread as a guide in tapping a straight hole. This style of tap is widely used in repairing damaged spark plug threads.



Spiral Flute

Spiral Flute taps are recommended for machine tapping for all blind hole applications, particularly in soft materials such as copper, magnesium and aluminium which produce long stringy swarf.



Spiral Point

Spiral Point Taps are recommended for machine tapping through holes. These taps provide for chip clearance within the lead of the tap.



Recoil taps can be supplied in different surface coatings for special order requirements.

Surface Coatings

Benefits of surface coatings include:

- Longer tool life
- Increased productivity
- Tools can be run at higher feeds and speeds
- Lower maintenance costs

Titanium Carbonitride - TiCNite (TiCN)

TiCNite coated taps have a very high surface hardness and are generally tougher than other coating materials. It has a high resistance to edge chipping.

Titanium Nitride - TiNite (TiN)

TiNite coating is a good choice for protecting the tap. It can achieve a longer life than uncoated taps and can be used at higher speeds.

Chromium Nitride (CrN)

This PVD coating was developed for use in non-ferrous areas where titanium based coatings were not successful. It is recommended for the machining and forming of titanium and copper and is harder than conventional chrome plating. The PVD coating process has no environmental side effects.

Recoil Tap Part Numbering System

The system of identification used for Recoil taps is categorised into 2 primary sections i). Inch threads, ii). Metric Threads. The tap annotation for both thread designations is very similar and therefore easy to follow.

Tap Part Number	4	3	04	5
Inch series	Product	Thread Type	Thread Size Diameter in 1/16"	Tap Style
	4=Tap	3 = UNC 4= UNF	04 = 1/4"	4= taper 5=intermediate 6=bottoming 7=pilot nose 8=spiral point 9=spiral flute
Metric Series		5=Coarse 7=Medium 8=Extra Fine	04 = 4mm	4= taper 5=intermediate 6=bottoming 7=pilot nose 8=spiral point 9=spiral flute

Recoil Tap Part Numbers and Dimensional Data

Unified Thread Series

THREAD SIZE	TAPER	INTERMEDIATE	BOTTOMING	SPIRAL POINT	SPIRAL FLUTE	OVERALL LENGTH	THREAD LENGTH	SHANK DIAMETER	SQUARE DRIVE
UNC									
2-56	43524	43525	43526	43528	43529	1.875	0.562	0.141	0.110
3-48	43534	43535	43536	43538	43539	1.937	0.625	0.141	0.110
4-40	43544	43545	43546	43548	43549	2.000	0.687	0.141	0.110
5-40	43554	43555	43556	43558	43559	2.125	0.750	0.168	0.131
6-32	43564	43565	43566	43568	43569	2.375	0.875	0.194	0.152
8-32	43584	43585	43586	43588	43589	2.375	0.937	0.220	0.165
10-24	43604	43605	43606	43608	43609	2.500	1.000	0.255	0.191
12-24	43624	43625	43626	43628	43629	2.718	1.125	0.318	0.238
1/4-20	43044	43045	43046	43048	43049	2.718	1.125	0.318	0.238
5/16-18	43054	43055	43056	43058	43059	2.937	1.250	0.381	0.286
3/8-16	43064	43065	43066	43068	43069	3.375	1.656	0.367	0.275
7/16-14	43074	43075	43076	43078	43079	3.593	1.656	0.429	0.322
1/2-13	43084	43085	43086	43088	43089	3.812	1.812	0.480	0.360
9/16-12	43094	43095	43096	43098	43099	4.031	1.812	0.542	0.406
5/8-11	43104	43105	43106	43108	43109	4.250	2.000	0.590	0.442
3/4-10	43124	43125	43126	43128	43129	4.687	2.218	0.697	0.523
7/8-9	43144	43145	43146	43148	43149	5.125	2.500	0.800	0.600
1-8	43164	43165	43166	43168	43169	5.750	2.562	1.021	0.766
11/8-7	43184	43185	43186	-	-	6.062	3.000	1.108	0.831
11/4-7	43204	43205	43206	-	-	6.375	3.000	1.233	0.925
13/8-6	43224	43225	43226	-	-	6.687	3.187	1.305	0.979
1 1/2-6	43244	43245	43246	-	-	7.000	3.187	1.430	1.072
UNF									
3-56	44534	44535	44536	43538	43589	1.937	0.625	0.141	0.110
4-48	44544	44545	44546	44548	44549	2.000	0.687	0.141	0.110
6-40	44564	44565	44566	44568	44569	2.125	0.750	0.168	0.131
8-36	44584	44585	44586	44588	44589	2.375	0.937	0.220	0.165
10-32	44604	44605	44606	44608	44609	2.500	1.000	0.255	0.191
12-28	44624	44625	44626	-	-	2.718	1.125	0.318	0.238
1/4-28	44044	44045	44046	44048	44049	2.718	1.125	0.318	0.238
5/16-24	44054	44055	44056	44058	44059	2.937	1.250	0.381	0.286
3/8-24	44064	44065	44066	44068	44069	3.156	1.438	0.323	0.242
7/16-20	44074	44075	44076	44078	44079	3.375	1.656	0.367	0.275
1/2-20	44084	44085	44086	44088	44089	3.593	1.656	0.429	0.322
9/16-18	44094	44095	44096	44098	44099	3.812	1.812	0.480	0.360
5/8-18	44104	44105	44106	44108	44109	4.031	1.812	0.542	0.406
3/4-16	44124	44125	44126	44128	44129	4.468	2.000	0.652	0.489
7/8-14	44144	44145	44146	44148	44149	5.125	2.500	0.800	0.600
1-12	44164	44165	44166	44168	44169	5.437	2.562	0.896	0.672
1-14	44164-14	44165-14	44166-14	-	-	5.437	2.562	0.896	0.672
11/8-12	44184	44185	44186	-	-	5.750	2.562	1.021	0.766
11/4-12	44204	44205	44206	-	-	6.062	3.000	1.108	0.831
13/8-12	44224	44225	44226	-	-	6.375	3.000	1.233	0.925
1 1/2-12	44244	44245	44246	-	-	6.687	3.187	1.305	0.979

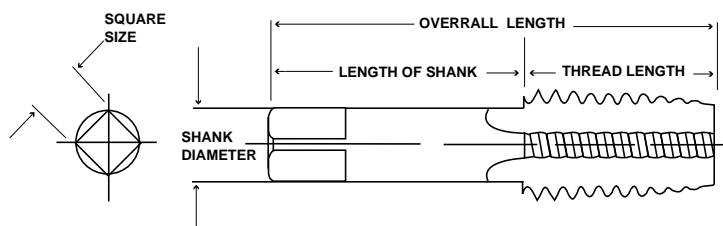

Note: Tap dimensional are based on American Standards (ANSI)

Recoil Tap Part Numbers and Dimensional Data

Metric Series

THREAD SIZE	TAPER	INTERMEDIATE	BOTTOMING	SPIRAL POINT	SPIRAL FLUTE	OVERALL LENGTH	THREAD LENGTH	SHANK DIAMETER	SQUARE DRIVE
METRIC COARSE									
M2 x 0.4	45024	45025	45026	45028	45029	45	10	2.80	2.24
M2.2 x 0.45	45014	45015	45016	45018	45019	48	11	3.15	2.50
M2.5 x 0.45	45254	45255	45256	45258	45259	48	11	3.15	2.50
M3 x 0.5	45034	45035	45036	45038	45039	50	13	3.55	2.80
M3.5 x 0.6	45354	45355	45356	45358	45359	53	13	4.50	3.55
M4 x 0.7	45044	45045	45046	45048	45049	58	16	5.00	4.00
M5 x 0.8	45054	45055	45056	45058	45059	66	19	6.30	5.00
M6 x 1	45064	45065	45066	45068	45069	72	22	8.00	6.30
M7 x 1	45074	45075	45076	-	-	72	22	9.00	7.10
M8 x 1.25	45084	45085	45086	45088	45089	80	24	10.00	8.00
M9 x 1.25	45094	45095	45096	-	-	85	25	8.00	6.30
M10 x 1.5	45104	45105	45106	45108	45109	89	29	9.00	7.10
M11 x 1.5	45114	45115	45116	-	-	89	29	9.00	7.10
M12 x 1.75	45124	45125	45126	45128	45129	95	30	11.20	9.00
M14 x 2	45144	45145	45146	-	-	102	32	12.50	10.00
M15 x 2	45154	45155	45156	-	-	112	37	14.00	11.20
M16 x 2	45164	45165	45166	45168	45169	112	37	14.00	11.20
M18 x 2.5	45184	45185	45186	-	-	118	38	16.00	12.50
M20 x 2.5	45204	45205	45206	-	-	130	45	18.00	14.00
M22 x 2.5	45224	45225	45226	-	-	135	48	20.00	16.00
M24 x 3	45244	45245	45246	-	-	135	48	20.00	16.00
M27 x 3	45274	45275	45276	-	-	151	51	22.40	18.00
M30 x 3.5	45304	45305	45306	-	-	162	57	25.00	20.00
M30 x 3	45304-3	45305-3	45306-3	-	-	162	57	25.00	20.00
M33 x 3.5	45334	45335	45336	-	-	170	60	28.00	22.40
M36 x 4	45364	45365	45366	-	-	170	60	28.00	22.40
M39 x 4	45394	45395	45396	-	-	187	67	31.50	25.00
M42 x 4.5	45424	45425	45426	-	-	187	67	31.50	25.00
M42 X 4	45424-4	45425-4	45426-4	-	-	200	70	35.50	28.00
M52 X 5	45524	45525	45526	-	-	221	76	40.00	31.50
METRIC MEDIUM & FINE									
M8 X 1	47084	47085	47086	-	-	80	24	10.00	8.00
M9 X 1	47094	47095	47096	-	-	85	25	8.00	6.30
M10 X 1.25	47104	47105	47106	47108	47109	85	25	8.00	6.30
M10 X 1	48104	48105	48106	48108	48109	85	25	8.00	6.30
M11 x 1.25	47114	47115	47116	-	-	89	29	9.00	7.10
M11 x 1	48114	48115	48116	-	-	89	29	9.00	7.10
M12 x 1.5	47124	47125	47126	-	-	95	30	11.20	9.00
M12 x 1.25	48124	48125	48126	-	-	95	30	11.20	9.00
M14 x 1.5	47144	47145	47146	-	-	102	32	12.50	10.00
M14 x 1.25	48144	48145	48146	-	-	102	32	12.50	10.00
M15 x 1.5	47154	47155	47156	-	-	112	37	14.00	11.20
M16 x 1.5	47164	47165	47166	-	-	112	37	14.00	11.20
M18 x 2	47184	47185	47186	-	-	112	37	14.00	11.20
M18 x 1.5	48184	48185	48186	-	-	112	37	14.00	11.20
M20 x 2	47204	47205	47206	-	-	118	38	16.00	12.50
M20 x 1.5	48204	48205	48206	-	-	118	38	16.00	12.50
M22 x 2	47224	47225	47226	-	-	130	45	18.00	14.00
M22 x 1.5	48224	48225	48226	-	-	130	45	18.00	14.00
M24 x 2	47244	47245	47246	-	-	135	48	20.00	16.00
M24 x 1.5	48244	48245	48246	-	-	135	48	20.00	16.00

Note: The Taps listed above represent the most popular of the Recoil Taps available. Other sizes and types are available including BSF, BSW, NPT, BA, 8UN ETC.

Note: Tap dimensions based upon international (ISO) standard

Recoil Tapped Hole and Fitted Size Data

Unified Thread Series

UNC

SIZE	T.P.I	DRILL SIZE		TAPPED HOLE							
		UNC		A		B	C		C	E	
		MM	INCH	MIN DIA	MAJ DIA	CLASS 2B	CLASS 3B	CLASS 3B	CLASS 3B	INSERTS FITTED	
No.2	56	2.3	3/32	0.094	0.090	0.1092	0.0996	0.0976	0.989	0.0976	0.0667
No.3	48	2.7	No.36	0.108	0.104	0.1261	0.1147	0.1125	0.1139	0.1125	0.0764
No.4	40	3	No.31	0.122	0.118	0.1445	0.1307	0.1282	0.1298	0.1282	0.0849
No.5	40	3.4	No.29	0.135	0.131	0.1575	0.1437	0.1412	0.1429	0.1412	0.0979
No.6	32	3.7	No.25	0.150	0.145	0.1786	0.1611	0.1583	0.1601	0.1583	0.1042
No.8	32	4.4	11/64	0.175	0.171	0.2046	0.1872	0.1843	0.1862	0.1843	0.1302
No.10	24	5.0	13/64	0.205	0.199	0.2441	0.2204	0.2171	0.2193	0.2171	0.1449
No.12	24	5.6	15/64	0.230	0.225	0.2701	0.2465	0.2431	0.2454	0.2431	0.1709
1/4	20	6.7	17/64	0.270	0.261	0.3150	0.2863	0.2825	0.2851	0.2825	0.1959
5/16	18	8.3	21/64	0.334	0.325	0.3847	0.3529	0.3486	0.3515	0.3486	0.2524
3/8	16	9.9	25/64	0.398	0.389	0.4562	0.4203	0.4156	0.4189	0.4156	0.3073
7/16	14	11.5	29/64	0.463	0.453	0.5303	0.4890	0.4839	0.4875	0.4839	0.3602
1/2	13	13.0	17/32	0.527	0.517	0.5999	0.5554	0.5499	0.5537	0.5499	0.4167
9/16	12	14.5	19/32	0.591	0.581	0.6708	0.6225	0.6167	0.6208	0.6167	0.4723
5/8	11	16.5	21/32	0.656	0.645	0.7431	0.6903	0.6841	0.6885	0.6841	0.5266
3/4	10	19.75	25/32	0.783	0.772	0.8799	0.8216	0.8149	0.8196	0.8149	0.6417
7/8	9	23.0	29/32	0.912	0.899	1.0193	0.9543	0.9471	0.9522	0.9471	0.7547
1	8	26.0	11/32	1.042	1.027	1.1624	1.0890	1.0812	1.0868	1.0812	0.8647
1 1/8	7	29.5	15/32	1.170	1.156	1.3106	1.2262	1.2178	1.2239	1.2178	0.9704
1 1/4	7	33.0	19/32	1.295	1.281	1.4356	1.3514	1.3428	1.3490	1.3428	1.0954
1 3/8	6	36.0	113/32	1.431	1.411	1.5914	1.4926	1.4832	1.4900	1.4832	1.1946
1 1/2	6	39.0	117/32	1.556	1.536	1.7164	1.6177	1.6082	1.6151	1.6082	1.3196

UNF

SIZE	T.P.I	DRILL SIZE		TAPPED HOLE							
		UNF		A		B	C		C	E	
		MM	INCH	MIN DIA	MAJ DIA	CLASS 2B	CLASS 3B	CLASS 3B	CLASS 3B	INSERTS FITTED	
No.3	56	2.65	-	0.106	0.103	0.1222	0.1126	0.1106	0.1119	0.1106	0.0797
No.4	48	3.0	No.31	0.120	0.117	0.1391	0.1278	0.1255	0.1270	0.1255	0.0894
No.5	44	3.3	-	0.134	0.130	0.1545	0.1422	0.1398	0.1414	0.1398	0.1004
No.6	40	3.7	No.26	0.148	0.144	0.1705	0.1568	0.1542	0.1559	0.1542	0.1109
No.8	36	4.4	11/64	0.174	0.170	0.2001	0.1848	0.1820	0.1839	0.1820	0.1339
No.10	32	5.1	13/64	0.201	0.197	0.2306	0.2133	0.2103	0.2123	0.2103	0.1562
1/4	28	6.6	17/64	0.264	0.258	0.2964	0.2765	0.2732	0.2754	0.2732	0.2113
5/16	24	8.2	21/64	0.328	0.322	0.3666	0.3433	0.3395	0.3421	0.3395	0.2674
3/8	24	9.8	25/64	0.390	0.384	0.4291	0.4059	0.4020	0.4047	0.4020	0.3299
7/16	20	11.5	29/64	0.456	0.449	0.5025	0.4744	0.4700	0.4731	0.4700	0.3834
1/2	20	13.0	33/64	0.518	0.511	0.5650	0.5371	0.5325	0.5357	0.5325	0.4459
9/16	18	14.5	37/64	0.582	0.575	0.6347	0.6035	0.5986	0.6020	0.5986	0.5024
5/8	18	16.25	41/64	0.644	0.637	0.6972	0.6661	0.6611	0.6646	0.6611	0.5649
3/4	16	19.5	49/64	0.771	0.764	0.8312	0.7961	0.7906	0.7945	0.7906	0.6823
7/8	14	22.5	57/64	0.899	0.891	0.9678	0.9274	0.9214	0.9257	0.9214	0.7977
1	12	26.0	11/54	1.028	1.018	1.1083	1.0608	1.0542	1.0589	1.0542	0.9098
1 1/8	12	29.5	15/32	1.153	1.143	1.2333	1.1860	1.1792	1.1841	1.1792	1.0348
1 1/4	12	32.5	19/32	1.278	1.268	1.3583	1.3112	1.3042	1.3092	1.3042	1.1598
1 3/8	12	36.0	113/32	1.403	1.393	1.4833	1.4364	1.4292	1.4343	1.4292	1.2848
1 1/2	12	39.0	117/32	1.528	1.518	1.6083	1.5615	1.5542	1.5595	1.5542	1.4098

*Standard size drills are suggested even though in these sizes they vary slightly from minor diameter limits. Drill sizes are recommended only and test should be carried out to select the one suitable for the material involved.

Countersinking: It is recommended that a 120° countersink is provided before tapping to prevent a 'feather edge' at the start of the lead thread. When design prevents the use of a countersink, any feather edges or deformed material at the thread lead should be removed before tapping. This will facilitate insert installation and reduce the effects of removing the countersinking operation.

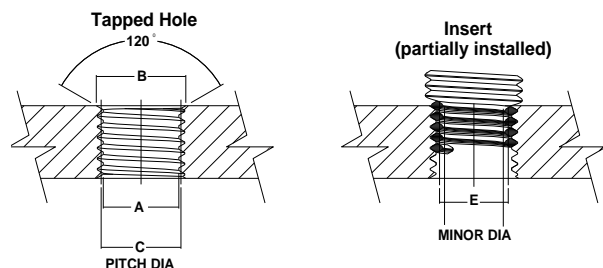

Drill, Tapping and Installation Depths

Unified Thread Series

Specifications for Drilling, Tapping and Installation depths

UNC THREAD SIZE	1D			1 1/2 D			2D			2 1/2 D			3D							
	Q	R	S	Q	R	S	Q	R	S	Q	R	S	Q	R	S					
2-56	0.086	0.068	0.166	0.148	0.129	0.111	0.209	0.191	0.172	0.154	0.252	0.234	0.215	0.197	0.295	0.277	0.258	0.240	0.338	0.320
3-48	0.099	0.078	0.193	0.172	0.148	0.127	0.242	0.221	0.198	0.177	0.292	0.271	0.248	0.227	0.342	0.321	0.297	0.276	0.391	0.370
4-40	0.112	0.087	0.224	0.199	0.168	0.143	0.28	0.255	0.224	0.199	0.336	0.311	0.280	0.255	0.392	0.367	0.336	0.311	0.448	0.423
5-40	0.125	0.100	0.237	0.212	0.187	0.162	0.300	0.275	0.250	0.225	0.362	0.337	0.312	0.287	0.425	0.400	0.375	0.350	0.487	0.462
6-32	0.138	0.107	0.279	0.247	0.207	0.176	0.348	0.316	0.276	0.245	0.417	0.385	0.345	0.314	0.486	0.454	0.414	0.383	0.555	0.523
8-32	0.164	0.133	0.305	0.273	0.246	0.215	0.387	0.355	0.328	0.297	0.469	0.437	0.410	0.379	0.551	0.519	0.492	0.461	0.633	0.601
10-24	0.190	0.148	0.377	0.336	0.285	0.243	0.472	0.431	0.380	0.338	0.567	0.526	0.475	0.433	0.662	0.621	0.570	0.528	0.757	0.716
12-24	0.216	0.174	0.404	0.362	0.324	0.282	0.512	0.470	0.432	0.390	0.620	0.578	0.540	0.498	0.727	0.686	0.648	0.606	0.836	0.794
1/4-20	0.250	0.200	0.475	0.425	0.375	0.325	0.600	0.550	0.500	0.450	0.725	0.675	0.625	0.575	0.850	0.800	0.750	0.700	0.975	0.925
5/16-18	0.312	0.257	0.562	0.507	0.469	0.413	0.719	0.663	0.625	0.569	0.875	0.819	0.781	0.726	1.031	0.976	0.937	0.882	1.187	1.132
3/8-16	0.375	0.312	0.656	0.594	0.562	0.500	0.844	0.781	0.750	0.687	1.031	0.969	0.937	0.875	1.219	1.156	1.125	1.062	1.406	1.344
7/16-14	0.437	0.366	0.759	0.687	0.656	0.585	0.978	0.906	0.875	0.804	1.196	1.125	1.094	1.022	1.415	1.343	1.312	1.241	1.634	1.562
1/2-13	0.500	0.423	0.846	0.769	0.750	0.673	1.096	1.019	1.000	0.923	1.346	1.269	1.250	1.173	1.596	1.519	1.500	1.423	1.846	1.769
9/16-12	0.562	0.479	0.937	0.854	0.844	0.760	1.219	1.135	1.125	1.042	1.500	1.417	1.406	1.323	1.781	1.698	1.687	1.604	2.062	1.979
5/8-11	0.625	0.534	1.034	0.943	0.937	0.846	1.347	1.256	1.250	1.159	1.659	1.568	1.562	1.471	1.972	1.881	1.875	1.784	2.284	2.193
3/4-10	0.750	0.650	1.200	1.100	1.125	1.025	1.575	1.475	1.500	1.400	1.950	1.850	1.875	1.775	2.325	2.225	2.250	2.150	2.700	2.600
7/8-9	0.875	0.764	1.375	1.264	1.312	1.201	1.812	1.701	1.750	1.639	2.250	2.139	2.187	2.076	2.687	2.576	2.625	2.514	3.125	3.014
18	1.000	0.875	1.563	1.437	1.500	1.375	2.062	1.937	2.000	1.875	2.562	2.437	2.500	2.375	3.062	2.937	3.000	2.875	3.625	3.437
1 1/8-7	1.125	0.982	1.768	1.625	1.687	1.545	2.330	2.187	2.250	2.107	2.893	2.750	2.812	2.670	3.455	3.312	3.375	3.232	4.018	3.875
1 1/4-7	1.250	1.107	1.893	1.750	1.875	1.732	2.518	2.375	2.500	2.357	3.143	3.000	3.125	2.982	3.768	3.625	3.750	3.607	4.393	4.250
1 3/8-6	1.375	1.208	2.125	1.958	2.062	1.896	2.812	2.646	2.750	2.583	3.500	3.333	3.437	3.270	4.187	4.021	4.125	3.958	4.875	4.708
1 1/2-6	1.500	1.333	2.250	1.083	2.250	2.083	3.000	2.833	3.000	2.833	3.750	3.583	3.750	3.583	4.500	4.333	4.500	4.333	5.250	5.083

UNC THREAD SIZE	1D			1 1/2 D			2D			2 1/2 D			3D							
	Q	R	S	Q	R	S	Q	R	S	Q	R	S	Q	R	S					
2-64	0.086	0.070	0.156	0.141	0.129	0.113	0.199	0.184	0.172	0.156	0.242	0.227	0.215	0.199	0.285	0.270	0.258	0.242	0.328	0.313
3-56	0.099	0.081	0.179	0.161	0.148	0.130	0.228	0.210	0.198	0.180	0.278	0.260	0.248	0.230	0.328	0.310	0.297	0.279	0.377	0.359
4-48	0.112	0.091	0.206	0.185	0.168	0.147	0.262	0.241	0.224	0.203	0.318	0.297	0.280	0.259	0.374	0.353	0.336	0.315	0.430	0.409
5-44	0.125	0.102	0.227	0.205	0.188	0.165	0.290	0.268	0.250	0.227	0.352	0.330	0.312	0.289	0.414	0.392	0.375	0.352	0.477	0.455
6-40	0.138	0.113	0.250	0.225	0.207	0.182	0.319	0.294	0.276	0.251	0.388	0.363	0.345	0.320	0.457	0.432	0.414	0.389	0.526	0.501
8-36	0.164	0.136	0.289	0.261	0.246	0.218	0.371	0.343	0.328	0.300	0.453	0.425	0.410	0.382	0.535	0.507	0.492	0.464	0.617	0.589
10-32	0.190	0.159	0.331	0.299	0.285	0.254	0.426	0.394	0.380	0.349	0.521	0.489	0.475	0.444	0.616	0.584	0.570	0.539	0.711	0.679
1/4-28	0.250	0.214	0.411	0.375	0.375	0.339	0.536	0.500	0.500	0.464	0.661	0.625	0.625	0.589	0.786	0.750	0.750	0.714	0.911	0.875
5/16-24	0.312	0.271	0.500	0.458	0.469	0.428	0.656	0.615	0.625	0.583	0.812	0.771	0.781	0.740	0.969	0.927	0.937	0.896	1.125	1.083
3/8-24	0.375	0.333	0.562	0.521	0.562	0.521	0.750	0.708	0.750	0.708	0.937	0.896	0.937	0.896	1.125	1.083	1.125	1.083	1.312	1.271
7/16-20	0.437	0.387	0.662	0.612	0.656	0.606	0.881	0.831	0.875	0.825	1.100	1.050	1.094	1.044	1.319	1.269	1.312	1.262	1.537	1.488
1/2-20	0.500	0.450	0.725	0.675	0.750	0.700	0.975	0.925	1.000	0.950	1.225	1.175	1.250	1.200	1.475	1.425	1.500	1.450	1.725	1.675
9/16-18	0.562	0.507	0.812	0.757	0.844	0.788	1.094	1.038	1.125	1.068	1.375	1.319	1.406	1.351	1.656	1.601	1.687	1.632	1.937	1.882
5/8-18	0.625	0.569	0.875	0.819	0.937	0.882	1.187	1.132	1.250	1.194	1.500	1.444	1.562	1.507	1.812	1.757	1.875	1.819	2.125	2.069
3/4-16	0.750	0.687	1.031	0.969	1.125	1.062	1.406	1.344	1.500	1.437	1.781	1.719	1.875	1.812	2.156	2.094	2.250	2.187	2.531	2.469
7/8-14	0.875	0.804	1.196	1.125	1.312	1.241	1.634	1.562	1.750	1.679	2.071	2.000	2.187	2.116	2.509	2.437	2.625	2.554	2.946	2.875
1 1/8-12	1.125	1.042	1.500	1.417	1.687	1.604	2.062	1.979	2.250	2.167	2.625	2.542	2.812	2.729	3.187	3.104	3.375	3.292	3.750	3.667
1 1/4-12	1.250	1.167	1.625	1.542	1.875	1.792	2.250	2.167	2.500	2.417	2.875	2.792	3.125	3.042	3.500	3.417	3.750	3.667	4.125	4.042
1 3/8-12	1.375	1.292	1.750	1.667	2.062	1.979	2.437	2.354	2.750	2.667	3.125	3.042	3.437	3.354	3.812	3.729	4.125	4.042	4.500	4.417
1 1/2-12	1.500	1.417	1.875	1.792	2.250	2.167	2.625	2.542	3.000	2.917	3.375	3.292	3.750	3.667	4.125	4.042	4.500	4.417	4.875	4.792

Drilling Depth: The minimum drilling depth "S" allows for one pitch chip clearance between the tip of the tap and the bottom of the drilled hole. "S" minimum allows for tap clearance, the maximum amount of insert set-down and the countersink. Where a spiral pointed tap is used, the drill depths shown should be increased to allow for chip clearance.

Fitted Insert: R = Maximum length of engaged portion of screw when tang is removed. Q = Minimum full tapped thread length. T = Minimum tapping depth - including 3 1/2 threads of plug tap. S = Minimum drill depth - excluding point.

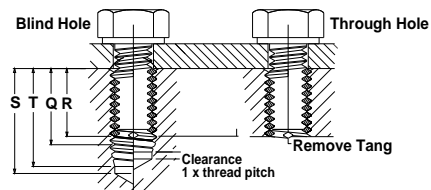

Recoil Tapped Hole and Fitted Size Data

Metric Thread Series

METRIC (ISO)		TAPPED HOLE							
SIZE	DRILL SIZE	A		B	C		C	E	
		MINOR DIA		MAJOR DIA	CLASS 5H		CLASS 6H	INSERTS FITTED	
M2 X 0.4	2.10	2.177	2.087	2.520	2.295	2.260	2.310	2.260	1.567
M2.2 X 0.45	2.30	2.397	2.297	2.785	2.532	2.492	2.547	2.492	1.713
M2.5 X 0.45	2.60	2.697	2.597	3.085	2.832	2.792	2.847	2.792	2.013
M3 X 0.5	3.10	3.220	3.108	3.650	3.367	3.325	3.384	3.325	2.459
M3.5 X 0.6	3.60	3.755	3.630	4.279	3.940	3.890	3.959	3.890	2.850
M4 X 0.7	4.10	4.292	4.152	4.909	4.509	4.455	4.529	4.455	3.242
M5 X 0.8	5.20	5.333	5.173	6.039	5.577	5.520	5.597	5.520	4.134
M6 X 1.0	6.20	6.406	6.216	7.299	6.719	6.650	6.742	6.650	4.917
M7 X 1.0	7.20	7.406	7.216	8.299	7.719	7.650	7.742	7.650	5.917
M8 X 1.0	8.20	8.406	8.216	9.299	8.719	8.650	8.742	8.650	6.917
M8 X 1.25	8.30	8.483	8.271	9.624	8.886	8.812	8.912	8.812	6.647
M9 X 1.25	9.30	9.483	9.271	10.624	9.886	9.812	9.912	9.812	7.647
M10 X 1.25	10.30	10.483	10.271	11.624	10.886	10.812	10.912	10.812	8.647
M10 X 1.5	10.30	10.561	10.325	11.949	11.061	10.974	11.089	10.974	8.376
M11 X 1.5	11.30	11.561	11.325	12.949	12.061	11.974	12.089	11.974	9.376
M12 X 1.25	12.30	12.483	12.271	13.624	12.898	12.812	12.926	12.812	10.647
M12 X 1.5	12.5	12.56	13.324	14.131	12.974	13.067	12.974	13.099	10.376
M12 X 1.75	12.40	12.644	12.379	14.273	13.236	13.137	13.271	13.137	10.106
M14 X 1.5	14.30	14.561	14.325	15.949	15.067	14.974	15.099	14.974	12.376
M14 X 2.0	14.40	14.733	14.433	16.598	15.406	15.299	15.444	15.299	11.835
M16 X 1.5	16.25	16.561	16.325	17.949	17.067	16.974	17.099	16.974	14.376
M16 X 2.0	16.50	16.733	16.433	18.598	17.406	17.299	17.444	17.299	13.835
M18 X 1.5	18.25	18.561	18.325	19.949	19.067	18.974	19.099	18.974	16.376
M18 X 2.0	18.50	18.733	18.433	20.598	19.406	19.299	19.444	19.299	15.835
M18 X 2.5	18.50	18.896	18.541	21.248	19.738	19.624	19.778	19.624	15.294
M20 X 1.5	20.25	20.561	20.325	21.949	21.067	20.974	21.099	20.974	18.376
M20 X 2.0	20.50	20.733	20.433	22.598	21.406	21.299	21.444	21.299	17.835
M20 X 2.5	20.50	20.896	20.541	23.248	21.738	21.624	21.778	21.624	17.294
M22 X 1.5	22.50	22.561	22.325	23.949	23.067	22.974	23.099	22.974	20.376
M22 X 2.0	22.50	22.733	22.433	24.598	23.406	23.299	23.444	23.299	19.835
M22 X 2.5	22.50	22.896	22.541	25.248	23.738	23.624	23.778	23.624	19.294
M24 X 2.0	24.25	24.733	24.433	26.598	25.414	25.299	25.454	25.299	21.835
M24 X 3.0	24.75	25.050	24.650	27.897	26.093	25.949	26.135	25.949	20.752
M27 X 3.0	27.50	28.050	27.650	30.897	29.093	28.949	29.135	28.949	23.752
M30 X 3.5	30.50	31.208	30.758	34.547	32.428	32.273	32.472	32.273	26.211
M33 X 3.5	33.50	34.208	33.758	37.547	35.428	35.273	35.472	35.273	29.211
M36 X 4.0	36.50	37.341	36.866	41.196	38.763	38.598	38.809	38.598	31.670
M39 X 4.0	39.50	40.341	39.866	44.196	41.763	41.598	41.809	41.598	34.670

*Standard size drills are suggested even though in these sizes they vary slightly from minor diameter limits. Drill sizes are recommended only and test should be carried out to select the one suitable for the material involved.

Countersinking: It is recommended that a 120° countersink is provided before tapping to prevent a 'feather edge' at the start of the lead thread. When design prevents the use of a countersink, any feather edges or deformed material at the thread lead should be removed prior to tapping. This will facilitate insert installation and reduce the effects of removing the countersinking operation.

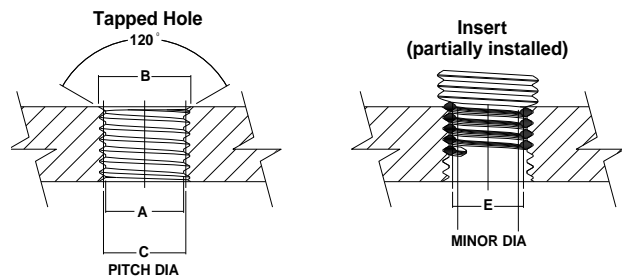

Drilling, Tapping and Installation Depths

Metric Thread Series

Specifications for Drilling, Tapping and Installation depths

METRIC (ISO) BASIC LENGTH OF INSERT IN TERMS OF NOMINAL DIAMETER OF SCREW "D" THREAD SIZE	1D					2D					2 1/2D					3D						
	Q	R	S	T	Q	R	S	T	Q	R	S	T	Q	R	S	T	Q	R	S	T	Q	
	1 1/2 D	1 D	1 D	1 D	1 D	1 D	1 D	1 D	1 D	1 D	1 D	1 D	1 D	1 D	1 D	1 D	1 D	1 D	1 D	1 D	1 D	
M2 X 0.4	2.00	1.60	3.80	3.40	3.00	4.40	4.00	4.40	4.00	3.60	5.80	5.40	5.40	5.00	4.60	6.80	6.40	6.40	6.00	5.60	7.80	7.40
M2.2 X 0.45	2.20	1.75	4.23	3.98	3.30	2.85	5.33	4.88	4.40	3.95	6.43	5.98	5.98	5.50	5.05	7.53	7.08	7.08	6.60	6.15	8.63	8.18
M2.5 X 0.45	2.50	2.05	4.53	4.08	3.75	3.30	5.78	5.33	5.00	4.55	7.03	6.58	6.58	6.25	5.80	8.28	7.83	7.83	7.50	7.05	9.53	9.08
M3 X 0.5	3.00	2.50	5.25	4.75	4.50	4.00	6.75	6.25	6.00	5.50	8.25	7.75	7.75	7.50	7.00	9.75	9.25	9.25	9.00	8.50	11.25	10.75
M3.5 X 0.6	3.50	2.90	6.20	5.60	5.25	4.65	7.95	7.35	7.00	6.40	9.70	9.10	9.10	8.75	8.15	11.45	10.85	10.85	10.50	9.90	13.20	12.60
M4 X 0.7	4.00	3.30	7.15	6.45	6.00	5.30	9.15	8.45	8.00	7.30	11.15	10.45	10.45	10.00	9.30	13.15	12.45	12.45	12.00	11.30	15.15	14.45
M4.5 X 0.75	4.50	3.75	7.88	7.13	6.75	6.00	10.13	9.38	9.00	8.25	12.38	11.63	11.63	11.25	10.50	14.63	13.88	13.88	13.50	12.75	16.88	16.13
M5 X 0.8	5.00	4.20	8.60	7.80	7.50	6.70	11.10	10.30	10.00	9.20	13.60	12.80	12.80	12.50	11.70	16.10	15.30	15.30	15.00	14.20	18.60	17.80
M6 X 1.0	6.00	5.00	10.50	9.50	9.00	8.00	13.50	12.50	12.00	11.00	16.50	15.50	15.50	15.00	14.00	19.50	18.50	18.50	18.00	17.00	22.50	21.50
M7 X 1.0	7.00	6.00	11.50	10.50	10.50	9.50	15.00	14.00	14.00	13.00	18.50	17.50	17.50	17.50	16.50	22.00	21.00	21.00	20.00	20.00	25.50	24.50
M8 X 1.0	8.00	7.00	12.50	11.50	12.00	11.00	16.50	15.50	15.50	15.00	20.50	19.50	19.50	20.00	19.00	24.50	23.50	23.50	24.00	23.00	28.50	27.50
M8 X 1.25	8.00	6.75	13.63	12.38	12.00	10.75	17.63	16.38	16.00	14.75	21.63	20.38	20.38	20.00	18.75	25.63	24.38	24.38	24.00	22.75	29.63	28.38
M9 X 1.25	9.00	7.75	14.63	13.38	13.50	12.25	19.13	17.88	18.00	16.75	23.63	22.38	22.38	22.50	21.25	28.13	26.88	26.88	27.00	25.75	32.63	31.38
M10 X 1.25	10.00	8.75	15.63	14.38	15.00	13.75	20.63	19.38	20.00	18.75	25.63	24.38	24.38	25.00	23.75	30.63	29.38	29.38	30.00	28.75	35.63	34.38
M10 X 1.5	10.00	8.50	16.75	15.25	15.00	13.50	21.75	20.25	20.00	18.50	26.75	25.25	25.25	25.00	23.50	31.75	30.25	30.25	30.00	28.50	36.75	35.25
M11 X 1.5	11.00	9.50	17.75	16.25	16.50	15.00	23.25	21.75	22.00	20.50	28.75	27.25	27.25	27.50	26.00	34.25	32.75	32.75	33.00	31.50	39.75	38.25
M12 X 1.25	12.00	10.75	17.63	16.38	18.00	16.75	23.63	22.38	24.00	22.75	29.63	27.38	27.38	30.00	28.75	35.63	34.38	34.38	36.00	34.75	41.63	40.38
M12 X 1.5	12.00	10.50	18.75	17.25	18.00	16.50	24.75	23.25	24.00	22.50	30.75	29.25	29.25	30.00	28.50	36.75	35.25	35.25	36.00	34.50	42.75	41.25
M12 X 1.75	12.00	10.25	19.88	18.13	18.00	16.25	25.88	24.13	24.00	22.25	31.88	30.13	30.13	30.00	28.25	37.88	36.13	36.13	36.00	34.25	43.88	42.13
M14 X 1.5	14.00	12.50	20.75	19.25	21.00	19.50	27.75	26.25	28.00	26.50	34.75	33.25	33.25	35.00	33.50	41.75	40.25	40.25	42.00	40.50	48.75	47.25
M14 X 2.0	14.00	12.00	23.00	21.00	21.00	19.00	30.00	28.00	28.00	26.00	37.00	35.00	35.00	35.00	33.00	44.00	42.00	42.00	44.00	42.00	51.00	49.00
M16 X 1.5	16.00	14.50	22.75	21.25	24.00	22.50	30.75	29.25	32.00	30.50	38.75	37.25	37.25	40.00	38.50	46.75	45.25	45.25	48.00	46.50	54.75	53.25
M16 X 2.0	16.00	14.00	25.00	23.00	24.00	22.00	33.00	31.00	32.00	30.00	41.00	39.00	39.00	40.00	38.00	49.00	47.00	47.00	48.00	46.00	57.00	55.00
M18 X 1.5	18.00	16.50	24.75	23.25	27.00	25.50	33.75	32.25	36.00	34.50	42.75	41.25	41.25	45.00	43.50	51.75	50.25	50.25	54.00	52.50	60.75	59.25
M18 X 2.0	18.00	16.00	27.00	25.00	27.00	25.00	36.00	34.00	36.00	34.00	45.00	43.00	43.00	45.00	43.00	54.00	52.00	52.00	54.00	52.00	63.00	61.00
M18 X 2.5	18.00	15.50	29.25	26.75	27.00	24.50	38.25	35.75	36.00	33.50	47.25	44.75	44.75	45.00	42.50	56.25	53.75	53.75	54.00	51.50	65.25	62.75
M20 X 1.5	20.00	18.50	26.75	25.25	30.00	28.50	36.75	35.25	40.00	38.50	46.75	45.25	45.25	50.00	48.50	56.75	55.25	55.25	60.00	58.50	66.75	65.25
M20 X 2.0	20.00	18.00	29.00	27.00	30.00	28.00	39.00	37.00	40.00	38.00	49.00	47.00	47.00	50.00	48.00	59.00	57.00	57.00	60.00	58.00	69.00	67.00
M20 X 2.5	20.00	17.50	31.25	28.75	30.00	27.50	41.25	38.75	40.00	37.50	51.25	48.75	48.75	50.00	47.50	61.25	58.75	58.75	60.00	57.50	71.25	68.75
M22 X 1.5	22.00	20.50	28.75	27.25	33.00	31.50	39.75	38.25	44.00	42.50	50.75	49.25	49.25	55.00	53.50	61.75	60.25	60.25	66.00	64.50	72.75	71.25
M22 X 2.0	22.00	20.00	31.00	29.00	33.00	31.00	42.00	40.00	44.00	42.00	53.00	51.00	51.00	55.00	53.00	64.00	62.00	62.00	66.00	64.00	75.00	73.00
M22 X 2.5	22.00	19.50	33.25	30.75	33.00	30.50	44.25	41.75	44.00	41.50	55.25	52.75	52.75	55.00	52.50	66.25	63.75	63.75	66.00	63.50	77.25	74.75
M24 X 2.0	24.00	22.00	33.00	31.00	36.00	34.00	45.00	43.00	48.00	46.00	57.00	55.00	55.00	60.00	58.00	69.00	67.00	67.00	72.00	70.00	81.00	79.00
M24 X 3.0	24.00	21.00	37.50	34.50	36.00	33.00	49.50	46.50	48.00	45.00	61.50	58.50	58.50	60.00	57.00	73.50	70.50	70.50	72.00	69.00	85.50	82.50
M27 X 3.0	27.00	24.00	40.50	37.50	40.50	37.50	54.00	51.00	54.00	51.00	67.50	64.50	64.50	67.50	64.50	81.00	78.00	78.00	81.00	78.00	94.50	91.50
M30 X 3.5	30.00	26.50	45.75	42.25	45.00	41.50	60.75	57.25	60.00	56.50	75.75	72.25	72.25	75.00	71.50	90.75	87.25	87.25	90.00	86.50	105.75	102.25
M33 X 3.5	33.00	29.50	48.75	45.25	49.50	46.00	65.25	61.75	66.00	62.50	81.75	78.25	78.25	82.50	79.00	98.25	94.75	94.75	99.00	95.50	114.75	111.25
M36 X 4.0	36.00	32.00	54.00	50.00	54.00	50.00	72.00	68.00	72.00	68.00	90.00	86.00	86.00	90.00	86.00	108.00	104.00	104.00	108.00	104.00	126.00	122.00
M39 X 4.0	39.00	35.00	57.00	53.00	58.50	54.50	76.50	72.50	78.00	74.00	96.00	92.00	92.00	97.50	93.50	115.50	111.50	111.50	117.00	113.00	135.00	131.00

Drill Depth: The minimum drilling depth "S" allows for one pitch chip clearance between the tip of the tap and the bottom of the drilled hole. "S" minimum allows for tap clearance, the maximum amount of insert set-down and the countersink. Where a spiral pointed tap is used, the drill depths shown should be increased to allow for chip clearance.

Fitted Insert: R = Maximum length of engaged portion of screw when tang is removed. Q = Minimum full tapped thread length. T = Minimum tapping depth - including 3 1/2 threads of plug tap. S = Minimum drill depth - excluding point.

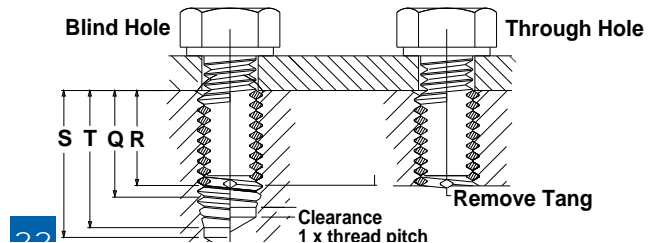

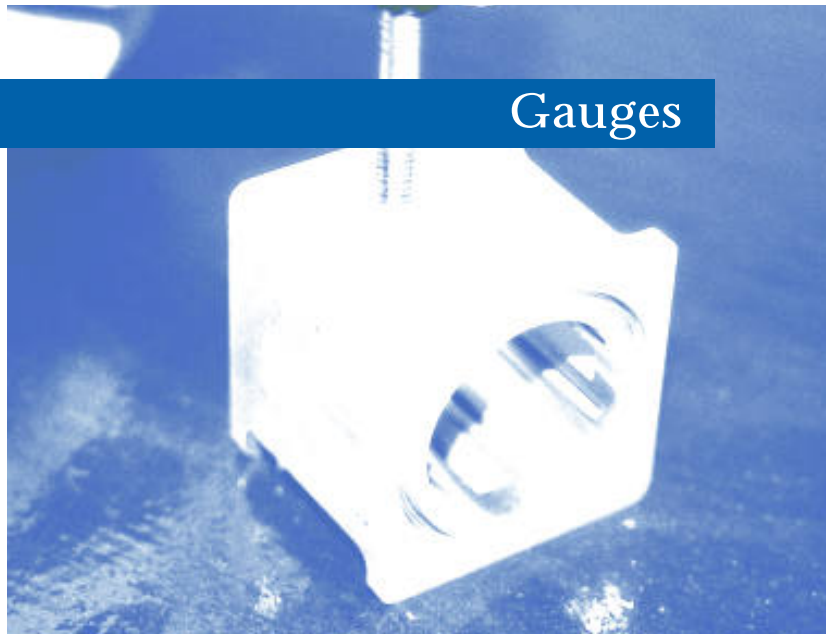

Recoil Thread Gauges

Thread gauging is recommended wherever precision threads are required. The quality of the tapped hole which accommodates the insert, determines the finished size and hole quality after the insert has been installed. If the finished tapped hole gauges satisfactorily, the installed insert will be within the thread tolerance.

Technical Information

Recoil gauges 1/2" M12 and below have at least a .0002" or 5um wear allowance on the Go nib. Gauge handle and all gauge nibs are marked with the extreme product limits for particular size and class of fit.

Where precision is required, 3B gauges should be used. When using locking inserts, 3B gauges should be used as close precision is required.

Recoil Inch Gauge Part Numbers

Unified Coarse

NOMINAL THREAD SIZE	WORKING GAUGES	
	3B Close Fit	2B Medium Fit
2 (.086) - 56	63523	63522
3 (.099) - 48	63533	63532
4 (.112) - 40	63543	63542
5 (.125) - 40	63553	63552
6 (.138) - 32	63563	63562
8 (.138) - 32	63583	63582
10 (.190) - 24	63603	63602
12 (.216) - 24	63623	63622
1/4 (.2500) - 20	63043	63042
5/16 (.3125) - 18	63053	63052
3/8 (.3750) - 16	63063	63062
7/16 (.4375) - 14	63073	63072
1/2 (.5000) - 13	63083	63082
9/16 (.5625) - 12	63093	63092
5/8 (.6250) - 11	63103	63102
11/16 (.6875) - 11	63113	63112
3/4 (.7500) - 10	63123	63122
7/8 (.8750) - 9	63143	63142
1 (1.0000) - 8	63163	63162
1-1/8 (1.1250) - 7	63183	63182
1-1/4 (1.2500) - 7	63203	63202
1-3/8 (1.3750) - 6	63223	63222
1-1/2 (1.5000) - 6	63243	63242

Unified Fine

NOMINAL THREAD SIZE	WORKING GAUGES	
	3B Close Fit	2B Medium Fit
3 (.099) - 56	64533	64532
4 (.112) - 48	64543	64542
6 (.138) - 40	64563	64562
8 (.164) - 36	64583	64582
10 (.190) - 32	64603	64602
1/4 (.2500) - 28	64043	64042
5/16 (.3125) - 24	64053	64052
3/8 (.3750) - 24	64063	64062
7/16 (.4375) - 20	64073	64072
1/2 (.5000) - 20	64083	64082
9/16 (.5625) - 18	64093	64092
5/8 (.6250) - 18	64103	64102
3/4 (.7500) - 16	64123	64122
7/8 (.8750) - 14	64143	64142
1 (1.0000) - 12	64163	64162
1 (1.0000) - 14	64163-14	64162-14
1-1/8 (1.1250) - 12	64183	64182
1-1/4 (1.2500) - 12	64203	64202
1-3/8 (1.3750) - 12	64223	64222
1-1/2 (1.5000) - 12	64243	64242

Fits and Tolerances

Recoil gauges are supplied for two different classes of fit (tolerances). These are close and medium tolerance.

Gauges are used to check the pitch diameter of the tapped hole, the No Go end of the gauge checks the pitch diameter is not too large and the Go end checks the pitch diameter is not too small.

THREAD / TOLERANCE	CLOSE	MEDIUM
Metric	4H5H	5H
UN	3B	2B
Imperial	CLOSE	MEDIUM

Recoil Metric Gauge Part Numbers

Metric Coarse

NOMINAL THREAD SIZE	WORKING GAUGES	
	4H5H Closefit	5H Medium Fit
M2 x 0.4	65024	65025
M2.2 x 0.45	65014	65015
M2.5 x 0.45	65254	65255
M3 x 0.5	65034	65035
M3.5 x 0.6	65354	65355
M4 x 0.7	65044	65045
M5 x 0.8	65054	65055
M6 x 1.0	65064	65065
M7 x 1.0	65074	65075
M8 x 1.25	65084	65085
M9 x 1.25	65094	65095
M10 x 1.5	65104	65105
M11 x 1.5	65114	65115
M12 x 1.75	65124	65125
M13 x 1.75	65134	65135
M14 x 2.0	65144	65145
M15 x 2.0	65154	65155
M16 x 2.0	65164	65165
M18 x 2.5	65184	65185
M20 x 2.5	65204	65205
M22 x 2.5	65224	65225
M24 x 3.0	65244	65245
M27 x 3.0	65274	65275
M30 x 3.5	65304	65305
M30 x 3.0	65304-3	65305-3
M36 x 4.0	65364	65365
M39 x 4.0	65394	65395
M42 x 4.5	65424	65425
M42 x 4.0	65424-4	65425-4

Metric Fine

NOMINAL THREAD SIZE	WORKING GAUGES	
	4H5H Closefit	5H Medium Fit
M8 x 1.0	67084	67085
M10 x 1.0	68104	68105
M10 x 1.25	67104	67105
M11 x 1.0	68114	68115
M11 x 1.25	67114	67115
M12 x 1.25	68124	68125
M12 x 1.5	67124	67125
M13 x 1.25	68134	68135
M13 x 1.5	67134	67135
M14 x 1.5	67144	67145
M15 x 1.5	67154	67155
M16 x 1.5	67164	67165
M18 x 1.5	68184	68185
M18 x 2.0	67184	67185
M20 x 1.5	68204	68205
M20 x 2.0	67204	67205
M22 x 1.5	68224	68225
M22 x 2.0	67224	67225
M24 x 1.5	68244	68245
M24 x 2.0	67244	67245
M26 x 1.5	68264	68265
M27 x 1.5	68274	68275
M27 x 2.0	67274	67275
M30 x 1.5	68304	68305
M30 x 2.0	67304	67305
M36 x 1.5	68364	68365
M36 x 3.0	67364	67365
M39 x 2.0	68394	68395
M39 x 3.0	67394	67395
M42 x 2.0	68424	68425
M42 x 3.0	67424	67425

Hand Installation Tools



Recoil Tools

Recoil supply a range of associated tooling to facilitate insert installation. The advantage of the Recoil tooling system is its simplicity, versatility and ease of use. The hand installation tooling range includes the manual installation tool, the semi production "Prewinder" type in slotted and threaded mandrel type as well as manual and spring operated tang break off tools.

Manual Tool

The standard Recoil insert installation tool is the most practical and simple to use for general applications. This tool may be used to install 1D through to 3D length inserts but care must be taken to ensure that the adjustable collar is correctly set to suit the particular type and length of the Recoil insert. If the collar is incorrectly set, the insert will not drive properly and the tool may slip off the tang as the insert enters the hole.

For general use, the collar should be adjusted such that the insert tang is positioned mid-way along the slot with the insert coils compressed. This will allow the insert free movement to suit the parent material thread pitch during installation.

If the installation tool is used to break off the tang, then it must be lifted clear of the insert following installation and replaced into the insert at 90 degrees to its drive position. This ensures that the tool is correctly placed on the insert tang. Tap the tool sharply downward to produce a clean tang break.

Note: The manual installation tool is not recommended for the installation of locking inserts.

Note: Recoil manual tools are not recommended for use with other brands of wire thread inserts.

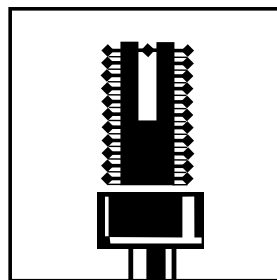

Collar Adjusted Too Low

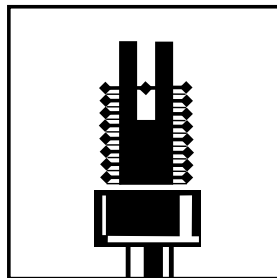

Collar Adjusted Correctly

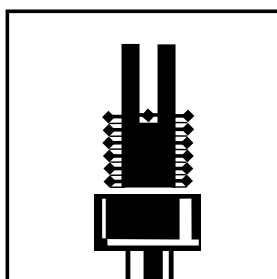

Collar Adjusted Too High

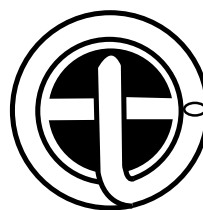

Tang Removal

Hand Installation Tools

Semi Production “Prewinder” Type Installation Tool

This type of tool is ideal for installing inserts in small production runs or in areas where compressed air or electricity are not available and offers a quicker alternative to the simple hand installation tool. The tool is suitable for use when installing free running and locking inserts.

Slotted Mandrel Type

The slotted mandrel tool allows the rapid installation of inserts, however it is best suited to free running inserts. This tool eliminates the need to wind the mandrel into and out of the insert offering quicker installation cycles.

Threaded Mandrel Type

The threaded mandrel type is suitable for the installation of free running and locking inserts. The mandrel is wound into the insert which is then wound into the tapped hole. The mandrel is removed by turning the crank in a counter clockwise direction, leaving the insert in place.

Note: The threaded mandrel type installation tool is recommended for installing locking inserts.



UNC

SIZE	PART No PLAIN (slotted)	PART No THREADED
#2-56		53526
#3-48		53536
#4-40	53542	53541
#5-40		53551
#6-32	53562	53561
#8-32	53582	53581
#10-24	53602	53601
#12-24		56621
1/4-20	53042	53041
5/16-18	53052	53051
3/8-16	53062	53061
7/16-14	53072	53071
1/2-13	53082	53081
9/16-12		53096
5/8-11		53106
3/4-10		53126
7/8-9		53146
1-8		53166
1 1/8-7		53186
1 1/4-7		53206
1 3/8-6		53226
1 1/2-6		53246

METRIC

SIZE	PART No PLAIN (slotted)	PART No THREADED
M2.2 x .45		55016
M2.5 x .45		55251
M3 x 0.5	55032	55031
M3.5 x 0.6		55351
M4 x 0.7	55042	55041
M5 x 0.8	55052	55051
M6 x 1.0	55062	55061
M7 x 1.0		55071
M8 x 1.25	55082	55081
M10 x 1.5	55102	55101
M12 x 1.75	55122	55121
M14 x 2.0		55146
M16 x 2.0		55166
M18 x 2.5		55186
M8 x 1.0		57081
M10 x 1.0		58101
M10 x 1.25	57102	57101
M12 x 1.25	58122	58121
M12 x 1.50	57122	57121
M14 x 1.5		57141
M16 x 1.5		57161
M18 x 1.5		58181

UNF

SIZE	PART No PLAIN (slotted)	PART No THREADED
#3-56		54531
#4-48		54541
#6-40		54561
#8-36		54581
#10-32	54602	54601
1/4-28	54042	54041
5/16-24	54052	54051
3/8-24	54062	54061
7/16-20	54072	54071
1/2-20	54082	54081
9/16-18		54091
5/8-18		54101
3/4-16		54121
7/8-14		54141
1-12		54161
1-14		54171
1 1/8-12		54181

Note: Part numbers ending in 6 are threaded mandrels only



Slotted Mandrel Type



Threaded Mandrel Type

Recoil Tang Break Tools

Recoil Tang Break Off Tools

Tang breakoff tools are available in hand, semi automatic spring type and pneumatic. The Spring Loaded and Pneumatic tang break tools are recommended for removal of tangs in production applications. For large diameter fine thread inserts, ie M18-1.5 and above, 3/4-16 and above, the use of long nose pliers is an alternative method to break the tang.

Manual Tang Break Tool

The simple Recoil Manual Tang Removal Tool is suitable for low volume tang removal and is used for insert sizes up to 1/2" or M12. On larger sizes the multipurpose Recoil installation and tang break tool should be used. For tang removal, the tool is simply lifted and turned 90°, which will put the slot at right angles to the tang, then pushed downward with a sharp blow.

Spring Loaded Tang Break Tool

Spring Loaded Tang Break Tools offer effective removal of insert tangs and are suited from medium to large insert usage. Being spring loaded this tool requires no external power source and is suitable for tang removal on insert sizes up to 1/2" or M12. This tool is a spring loaded punch and when the tool is pushed down, the pin punches downward breaking off the tang.

Pneumatic Tang Break Tool

The Pneumatic Tang Break Tool is designed for high volume applications where rapid, effortless tang removal is required on insert sizes up to 3/4" or M20. This tool works on the same basis as the spring loaded tool, except the pin punches downward when an air cylinder is actuated by the valve.

Reference Table for Tang Breaking Tool

INSERT PART	MANUAL			
	TANG BREAK	COMBINED INSTALLATION TANG BREAK	SPRING (ATBO) TYPE	PNEUMATIC TYPE
2-56, M2, M2.2	59060		59061	59062
3-48, 3-56, M2.5	59070	50069	59071	59072
4-40, 4-48	59080	50077	59081	59082
5-40, M3	59090	50089	59091	59092
6-32, 6-40, M3.5	59100	50095	59101	59102
8-32, 8-36, M4	59130	50125	59121	59132
10-24, 10-32, 12-24, M5	59140	50140	59141	59142
10-32, M5	59160	50156	59141	59142
1/4-20, 1/4-28, M6	59190	50188	59181	59192
5/16-18	59220	50219	59241	59252
5/16-24, M8	59250	50250	59291	59252
3/8-16, M10-1.5	59280	50281	59291	59252
3/8-24, M10-1.25	59310	50313	59291	59252
7/16-14, 7/16-20, M11-1.25	59340	50344		
1/2-12, 1/2-13, M12-1.75	59380	50375		59332
M14-1.5		50438		59462
M16-1.5, 2		50500		
M18-1.5, 2, 2.5		50591		

Extracting Tool

Should inserts need to be removed, the use of the Recoil extraction tool is recommended. Extraction tools are simple and easy to use. As correct positioning will make the extraction easier, the tool should be turned 90° from the start of the coil allowing easy winding out of the insert. If the extraction tool is not gripping the insert, the edges can be resharpened.

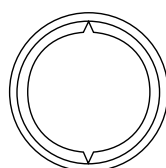
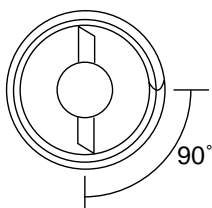

Should the extracting tool not grip the insert, file a small notch in the insert for the tool to bite into.

Size of extraction tool and related size inserts

Size	Inch	Metric	Part No.
No.2	4-40 - 3/8	M3 - M10	50002
No.3	6-32 - 1	M4 - M24	50003
No.4	1 1/8 - 1/2	M27 - M39	50004
No.5	1 1/2 - 2 1/2	M8 - M65	50005





The Recoil range of power tooling ensures consistent high volume thread insert installation for a variety of applications.

Recoil powered installation tools may be supplied for use with either a compressed air supply or via a stabilised low voltage power supply to suit your particular requirements. Both equipment types offer significant productivity gains for high volume insert use.

Pneumatic Power Tooling

- Wide thread size range #2-56 through 3/4", or M2.5 through M16, coarse and fine.
- Rugged and versatile air motor.
- May be used with captive strip feed or bulk insert insertion.
- Standard speed 1500 rpm.
- Auto reverse on release of trigger.

The complete pneumatic insert installation tool comprises of 3 components:-

- Air motor with single lever control to install and retract.
- Adaptor - connect the motor to the insert drive nozzle - small and large types.
- Front end assembly nozzle to suit the particular insert thread size.

Electric Power Tooling

- Size range #2-56 through 1/4", M2.5 through M8
- Auto reverse on installation
- Clean, lightweight, quiet
- Suitable for bulk insert only

Recoil offer two different types of air motors, the 56010 series and the NR-HL series. For further details please contact your Recoil distributor.

Compressed Air Supply for Pneumatic Installation Tools

PRESSURE RECOMMENDATIONS										
FOR INSERT SIZE										
Inch	#2	#4	#5	#6	#8 #10	1/4"	5/16"	3/8"	7/16"	1/2"
Metric	M2 - 2.5	M2.5	M3	M3.5	M4, M5	M6, M7	M8	M10	-	M12
RECOMMENDED PRESSURE										
psi	25	20-30	25-30	40	45	50-60	60	70	70-80	90
bar	1.70	1.3-2.0	1.7-2.0	2.72	3.06	3.4-4.0	4.0	4.76	4.7-5.4	6.0
MPa	0.172	0.138-0.206	0.172-0.206	0.275	0.310	.344-0.413	0.413	0.482	0.482-0.551	0.620

If difficulty is encountered within the above settings, reduce the pressure until the optimum setting is found.

It is imperative that a regulated moisture - free and filtered air supply is used with all Recoil pneumatic tooling. Reliability will be affected if an adequate and regulated air supply is not used with these tools.

Guidelines for typical Recoil insert tool pressure requirements are shown above.

Recoil Inserts-Pneumatic Installation Tooling

The following table denotes the part numbers of all pneumatic installation tooling for the most popular thread size ranges.

THREAD SIZE	FRONT-END ASSEMBLY	ADAPTOR	AIR MOTOR	AIR MOTOR & ADAPTOR	AIR MOTOR & ADAPTOR
	PART No.	PART No.	PART No.	PART No.	PART No.
UNC					
2-56	M8551-02-15	M8550R	M8510-1	M8500-1	NR-HL 1409
4-40	M8551-04-15	M8550R	M8510-1	M8500-1	NR-HL 1409
5-40	M8551-05-15	M8550R	M8510-1	M8500-1	NR-HL 1409
6-32	M8551-06-15	M8550R	M8510-1	M8500-1	NR-HL 1409
8-32	M8551-2-15	M8550R	M8510-1	M8500-1	NR-HL 1409
10-24	M8551-3-15	M8550R	M8510-1	M8500-1	NR-HL 1409
1/4-20	M8551-4-15	M8550R	M8510-1	M8500-1	NR-HL 1409
5/16-18	M8251-5-15	M85501R	M8510-1	M8500-2	
3/8-16	M8251-6-15	M85501R	M8510-1	M8500-2	
7/16-14	M8251-7-15	M85501R	M8510-1	M8500-2	
1/2-13	M8251-8-15	M85501R	M8510-1	M8500-2	
5/8-11	M8251-9	M85502R	M8510-2	M8500-3	
3/4-10	M8251-10	M85502R	M8510-2	M8500-3	
UNF					
6-40	M8552-06-15	M8550R	M8510-1	M8500-1	NR-HL 1409
10-32	M8552-3-15	M8550R	M8510-1	M8500-1	NR-HL 1409
1/4-28	M8552-4-15	M85501R	M8510-1	M8500-2	NR-HL 1409
5/16-24	M8252-5-15	M85501R	M8510-1	M8500-2	
3/8-24	M8252-6-15	M85501R	M8510-1	M8500-2	
7/16-20	M8252-7-15	M85501R	M8510-1	M8500-2	
1/2-20	M8251-8-15	M85501R	M8510-1	M8500-2	
5/8-18	M8251-9	M85502R	M8510-2	M8500-3	
3/4-16	M8251-10	M85502R	M8510-2	M8500-3	
METRIC COARSE					
2.2 x .45	M8751-2.2-15	M8550-R	M8510-1	M8500-1	NR-HL 1409
2.5 x .45	M8751-2.2-15	M8550-R	M8510-1	M8500-1	NR-HL 1409
3 x .5	M8751-3-15	M8550-R	M8510-1	M8500-1	NR-HL 1409
3.5 x .6	M8751-3.5-15	M8550-R	M8510-1	M8500-1	NR-HL 1409
4 x .7	M8751-4-15	M8550-R	M8510-1	M8500-1	NR-HL 1409
5 x .8	M8951-5-15	M8550-R	M8510-1	M8500-1	NR-HL 1409
6 x 1	M8751-6-15	M8550-R	M8510-1	M8500-1	NR-HL 1409
7 x 1	M8751-7-15	M8550-R	M8510-1	M8500-1	
8 x 1.25	M8751-8-15	M8550-1R	M8510-1	M8500-2	
10 x 1.5	M8751-10-15	M8550-1R	M8510-1	M8500-2	
12 x 1.75	M8751-12-15	M8550-1R	M8510-1	M8500-2	
16 x 2	M8751-16	M8550-2R	M8510-2	M8500-3	
METRIC FINE					
8 x 1	M8755-8-15	M8550-1R	M8510-1	M8500-2	
10 x 1	M8755-10-15	M8550-1R	M8510-1	M8500-2	
10 x 1.25	M8756-10-15	M8550-1R	M8510-1	M8500-2	
12 x 1.25	M8756-10-15	M8550-1R	M8510-1	M8500-2	
12 x 1.5	M8753-10-15	M8550-1R	M8510-1	M8500-2	
14 x 1.5	M8753-14	M8550-1R	M8510-1	M8500-2	



Strip-Feed Inserts for Power Tools



To complete the Recoil power installation tools, Recoil has inserts available on strip (M2.5-M12, #2-5/16) to optimise production with increased installation cycles and reduced operator fatigue.

Recoil strip feed inserts provide many advantages such as:

- Minimised handling costs
- Faster, more economical assembly
- Positive inventory control

When used in combination with Recoil pneumatic installation tooling, each insert is retained in a plastic strip which is passed through a slot in the front end assembly nozzle, indexing the insert to the installation mandrel.

Recoil 'Strip-Feed' inserts are available in most common thread diameters and lengths in addition to the various surface finishes which are available on standard Recoil bulk inserts.

The table shows some commonly supplied Recoil 'Strip-Feed' inserts and defines the typical quantity of inserts supplied per reel for each given thread size.

Additional insert diameters and lengths may be available to special order.

Reference Table for Recoil Strip Feed Inserts.

INSERT PART NUMBERS	INSERT SIZE	INSERT LENGTH	NUMBER PER REEL	REEL TYPE
3542SF, 3543SF, 3544SF	4-40	1-2D	1000	Small
3562SF	6-32	1D	1000	Small
3563SF, 3564SF	6-32	1.5-2D	1000	Large
3582SF, 3583SF, 3584SF	8-32	1-2D	1000	Large
3602SF	10-24	1D	1000	Large
3603SF, 3604SF	10-24	1.5-2D	500	Large
3622SF, 3623SF	12-24	1-1.5D	500	Large
3042SF, 3043SF, 3044SF	1/4-20	1-1.5D	500	Large
3052SF, 3053SF, 3054SF	5/16-18	1-2D	250	Large
3063SF	3/8-16	1.5D	250	Large
4602SF	10-32	1D	1000	Large
4603SF, 4604SF	10-32	1.5-2D	500	Large
4042SF, 4043SF, 4044SF	1/4-28	1-2D	500	Large
4052SF, 4053SF, 4054SF	5/16-24	1-2D	250	Large
5252SF, 5253SF, 5254SF	M2.5	1D	1000	Small
5033SF, 5034SF	M3	1.5D	1000	Small
5353SF, 5354SF	M3.5	1.5-2D	1000	Small
5043SF, 5044SF	M4	1.5-2D	1000	Large
5042SF	M4	1D	1000	Small
5052SF	M5	1D	1000	Large
5053SF, 5054SF	M5	1.5-2D	500	Large
5062SF, 5063SF, 5064SF	M6	1-2D	500	Large
5082SF, 5083SF, 5084SF	M8-1.25	1.5-2D	200	Large
5122SF, 5123SF, 5124SF	M12-1.75	1-2D	125	Large

Note: Strip feed inserts are also available with different finishes and coatings. Super reels are also available increasing the number of inserts available per reel.

Note: Prefixes of 0 are required for free running inserts and a prefix of 1 for locking inserts.

Thread Repair Kits



Recoil's innovative and cost effective thread repair kits are utilised world wide in industrial and automotive maintenance situations. Each kit contains:

- Quality high speed steel (HSS) ground thread intermediate (plug or 2nd) tap
- Quantity of inserts
- Installation / Tang break tool
- Easy to follow instructions
- Sturdy reusable container
- Recommended drill size on the label

Spark plug kits have pilot nose taps for accurate self alignment eliminating the need for drilling.

The table below denotes the Recoil Insert Kit part numbers for each available thread size together with details of insert quantities included with each thread repair kit. Range kits include a number of popular sizes in metric, inch or a combination suited to particular industries.

METRIC COARSE THREAD	PART NO	INSERTS PER KIT	METRIC MEDIUM THREAD	PART NO	INSERTS PER KIT	METRIC EXTRA FINE	PART NO	INSERTS PER KIT	SPARK PLUG THREAD	PART NO	INSERTS PER KIT
M2 x 0.4	35020	10									
M2.2 x .45	35010	10									
M2.5 x .45	35250	10									
M3 x 0.5	35030	10									
M3.5 x 0.6	35350	10									
M4 x 0.7	35040	10									
M5 x 0.8	35050	10									
M6 x 1.0	35060	10									
M7 x 1.0	35070	10									
M8 x 1.25	35080	10	M8 x 1	37080	10						
M9 x 1.25	35090	10	M9 x 1	37090	10						
M10 x 1.5	35100	10	M10 x 1.25	37100	10	M10 x 1.0	38101	10	M10 x 1.0	38100	10
M11 x 1.5	35110	5	M11 x 1.25	37110	5	M11 x 1.0	38110	5			
M12 x 1.75	35120	5	M12 x 1.5	37120	5	M12 x 1.25	38121	5	M12 x 1.25	38120	10
M13 x 1.75	35130	5	M13 x 1.5	37130	5	M13 x 1.25	38130	5			
M14 x 2.0	35140	5	M14 x 1.5	37140	5	M14 x 1.25	38141	5	M14 x 1.25	38140	10
M15 x 2.0	35150	5	M15 x 1.5	37150	5						
M16 x 2.0	35160	5	M16 x 1.5	37160	5						
M18 x 2.5	35180	5	M18 x 2.0	37180	5	M18 x 1.5	38181	5	M18 x 1.5	38180	5
M20 x 2.5	35200	5	M20 x 2.0	37200	5	M20 x 1.5	38200	5			
M22 x 2.5	35220	5	M22 x 2.0	37220	5	M22 x 1.5	38220	5			
M24 x 3.0	35240	5	M24 x 2.0	37240	5	M24 x 1.5	38240	5			
M27 x 3.0	35270	5	M27 x 2.0	37270	5	M27 x 1.5	38270	5			
M30 x 3.5	35300	5	M30 x 2.0	37300	5	M30 x 1.5	38300	5			
M30 x 3.0	35300-3	5									
M36 x 4.0	35360	4	M36 x 3.0	37360	4	M36 x 1.5	38360	4			
M39 x 4.0	35390	5	M39 x 3.0	37390	5	M39 x 2.0	38390	5			
M42 x 4.5	35420	5	M42 x 3.0	37420	4						
M42 x 4.0	35420-4	4									

Recoil Kits are available in both single size and Range-Kit versions.

Thread Repair Kits

UNC THREAD SIZE	PART NO.	PCS/ KIT	UNF THREAD SIZE	PART NO.	PCS/ KIT	BSF THREAD SIZE	PART NO.	PCS/ KIT
#2-56	33520	10	#3-56	34530	10	3/16-22	30030	10
#3-48	33530	10	#4-48	34540	10	1/4-26	30040	10
#4-40	33540	10	#6-40	34560	10	5/16-22	30050	10
#5-40	33550	10	#8-36	34580	10	3/8-20	30060	10
#6-32	33560	10	#10-32	34600	10	7/16-18	30070	5
#8-32	33580	10	#12-28	34620	10	1/2-16	30080	5
#10-24	33600	10	1/4-28	34040	10	9/16-16	30090	5
#12-24	33620	10	5/16-24	34050	10	5/8-14	30100	5
1/4-20	33040	10	3/8-24	34060	10	3/4-12	30120	5
5/16-18	33050	10	7/16-20	34070	5	7/8-11	30140	5
3/8-16	33060	10	1/2-20	34080	5	1-10	30160	5
7/16-14	33070	5	9/16-18	34090	5	1 1/4-9	30200	5
1/2-13	33080	5	5/8-18	34100	5	BSW THREAD SIZE	PART NO.	PCS/ KIT
9/16-12	33090	5	3/4-16	34120	5			
5/8-11	33100	5	7/8-14	34140	5	1/8-40	32020	10
11/16-11	33110	5	1 - 12	34160	5	3/16-24	32030	10
3/4-10	33120	5	1 - 14	34160-14	5	1/4-20	32040	10
7/8-9	33140	5	1 1/8-12	34180-14	5	5/16-18	32050	10
1 - 8	33160	5	1 1/4-12	34200	5	3/8-16	32060	10
1 1/8-7	33180	5	1 3/8-12	34220	5	7/16-14	32070	5
1 1/4-7	33200	5	1 1/2-12	34240	4	1/2-12	32080	5
1 3/8-6	33220	5	BSC OR BRASS	PART NO.	PCS/ KIT	9/16-12	32090	5
1 1/2-6	33240	4				5/8-11	32100	5
NPT THREAD SIZE	PART NO.	PCS/ KIT	1/4-26	30040	10	3/4-10	32120	5
1/8-27	36020	10	5/16-26	36500	10	7/8-9	32140	5
1/4-18	36040	10	3/8-26	36600	10	1-8	32160	5
3/8-18	36060	10	7/16-26	36700	5	1 1/8-7	32180	5
1/2-14	36080	5	1/2-26	36800	5	1 1/4-7	32200	5
3/4-14	36120	5	8 TPI UN THREAD SIZE	PART NO.	PCS/ KIT	1 3/8-6	32220	5
BSP THREAD SIZE	PART NO.	PCS/ KIT				1 1/8-8	36180	5
1/8-28	31020	10	1 1/4-8	36200	5	BA	PART NO.	PCS/ KIT
1/4-19	31040	10	1 3/8-8	36220	5			
3/8-19	31060	5	1 1/2-8	36240	4	1 BA	30510	10
1/2-14	31080	5	1 5/8-8	36260	4	2 BA	30520	10
5/8-14	31100	5	1 3/4-8	36280	4	4 BA	30540	10
3/4-14	31120	5	1 7/8-8	36300	4	6 BA	30560	10
1 - 11	31160	5	2 - 8	36320	4			
SPECIAL THREAD SIZE	PART NO.	PCS/ KIT	RANGE KITS					
UNEF			PART NO.			SIZES INCLUDE		
1/4-32	34040-32	10	33004	UNC - 1/4-20, 5/16-18, 3/8-16, 7/16-14, 1/2-13				
HARLEY			34004	UNF - 1/4-28, 5/16-24, 3/8-24, 7/16-20, 1/2-20				
1/4-24	34040-24	10	32004	BSW - 1/4-20, 5/16-18, 3/8-16, 7/16-14, 1/2-12				
7/16-16	34070-16	10	35004	METRIC - ISO - M5x.8, M6x1, M8x1.25, M10x1.5, M12x1.75				
CARBURETTOR			35005	METRIC - ISO - M6x1, M8x1.25, M10x1.5, M12x1.75, M16x2				
7/8-20	34140-20	5	38006	M/C (M/cycle) - M6x1, M8x1.25, M10x1, M10x1.25, M12x1.25, M14x1.25				
1 - 20	34160-20	5	38007	O.P.E. (Outdoor Power Equip't) - M5x.8, M6x1, M8x1.25, M14x1.25, 1/4-20, 5/16-18				
CUMMINS			38008	VW - M6x1, M7x1, M8x1.25 M10x1.5, M12x1.5, M14x1.25				
11/16-16	34110-16	5	30004	BSF - 1/4-26, 5/16-22, 3/8-20, 7/16-18, 1/2-16				
			33005	M6x1, M8x1.25, M10x1.5, M12x1.75, M14x1.25				

Specials can be provided to suit your particular requirements



The following design considerations should be evaluated to maximise the security and safety of the fastening assembly using Recoil wire inserts.

Boss Dimensions

Boss thickness is a function of size and strength requirements and also design of components. For optimum strength, the minimum wall thickness should be twice the maximum diameter of the STI Recoil Tap. For minimum requirements, a wall thickness of twice the bolt diameter to centre line may be adequate.

Boss Thickness

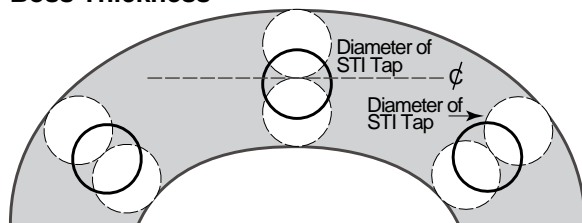

Edge Dimensions

The minimum edge distance recommended is the maximum diameter of the STI tap measured from the edge of the material to the centre line of the hole.

Edge Thickness

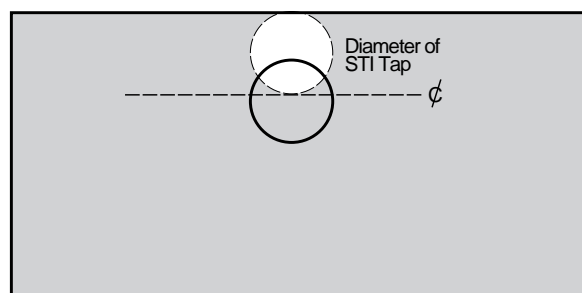

Minimum Material Thickness

The recommended minimum material thickness for through-hole applications is equal to the nominal length of the insert plus one pitch. This allows for proper countersinking and installation of the insert at 3/4 to 1 1/2 pitches below the surface of the component. In design critical applications, the minimum thickness may be reduced by eliminating the countersink and installing the insert to 1/4 to 1/2 pitch below the surface.

Class of Thread Fit

All Recoil inserts are produced to exacting tolerances where installation into the tapped hole will conform exactly to the parent material thread characteristics. It is therefore important that the tapped hole tolerances of either 2B or 3B (unified threads), or the applicable 4H5H and 5H (metric threads) combinations must be carefully controlled by precise tapping and gauging operations.

Gauging

Recoil inserts, when installed correctly in tapped and gauged holes, will conform with the tapped hole dimensions once the insert has been seated. Gauging of the tapped hole with the appropriate gauges prior to installing Recoil inserts is therefore highly recommended.

Bolt Engagement

Maximum strength of the bolted insert assembly will be achieved if the bolt or screw engages the full length of the insert. Ideally, the minimum bolt projection for safe engagement should be at least two pitches beyond the last coil of the insert.

Tang Removal

To achieve the optimum bolt engagement and hence maximum strength, the tang should be removed from the insert. Exceptions to this recommendation may be necessary in certain blind-hole applications involving light tensile bolt loading.

Design Method

The ultimate consideration is to design an assembly that balances the tensile strength of the bolt material against the shear strength of the parent material. With insert lengths available in 1, 1 1/2, 2, 2 1/2, and 3 times the nominal thread diameters, there are engagement lengths available to produce an assembly thread system where the bolt will fail without damage to the parent material or thread. The bolt must be fully engaged along the entire length of the insert to obtain this position.

Selection of the correct length insert can be determined from Table 1 referring to values for bolt ultimate strengths and parent material shear strengths. For intermediate strength value, use the next higher bolt tensile value or the next lower parent material shear strength.

Assembly strength is a function of shear area and the shear strength of the parent material, tensile strength and cross sectional area of the bolt. Table 1 provides a recommendation of the nominal length of insert which should be selected for a parent material of a certain shear strength, so that when a bolt is used with defined tensile properties, tensile failure of the bolt should occur before the insert is stripped away from the material in which it was inserted.

Table 1 (Source BS 7752: Part 1:1994)

SHEAR STRENGTH PARENT MATERIAL	TENSILE STRENGTH OF BOLT SELECTED (Ultimate Tensile Strength)						
	400 (MPa) 58,000 (psi)	500 (MPa) 72,000 (psi)	600 (MPa) 87,000 (psi)	800 (MPa) 116,000 (psi)	1000 (MPa) 145,000 (psi)	1200 (MPa) 174,000 (psi)	1400 (MPa) 203,000 (psi)
70 to 99 MPa (10.0 to 14.4 Ksi)	2.0D	2.5D	2.5D	-	-	-	-
100 to 149 MPa (14.5 to 21.5 Ksi)	1.5D	1.5D	2.0D	3.0D	-	-	-
150 to 199 MPa (21.7 to 28.9 Ksi)	1.0D	1.5D	1.5D	2.0D	2.5D	3.0D	-
200 to 249 MPa (29.0 to 36.1 Ksi)	1.0D	1.0D	1.0D	1.5D	2.0D	2.0D	2.5D
250 to 299 MPa (36.2 to 43.3 Ksi)	1.0D	1.0D	1.0D	1.5D	1.5D	2.0D	2.0D
300 to 349 MPa (43.5 to 50.6 Ksi)	1.0D	1.0D	1.0D	1.0D	1.5D	1.5D	2.0D
> 350 MPa (50.7 Ksi)	1.0D	1.0D	1.0D	1.0D	1.0D	1.5D	1.5D

Note: Inserts are available in different lengths which are measured by the diameter of the thread. For example the length of a 3D insert would be three times the diameter.

Note: Table 1 is for guidance only. It remains the responsibility of the user to ensure that the insert nominal length chosen is suitable for the particular application concerned.

Design Method

The following Procedure can be used to verify a joint design incorporating a wire thread insert.

1. Select size and strength of bolt to be used. (refer to table 2)
2. Determine tensile failure load of the selected bolt.
3. Determine shear strength of parent material for the installation of the insert. (refer to table 3)
4. Determine length of insert based on the shear strength capability of parent material.

Note: Information in referring to joint strength is intended as a guide only. Professional engineering advice must be sought when exact design calculations are required.

Design Example (Metric) Units

Step One:	Select Size and Strength of bolt to be used
Type	M16 x 2.0, SAE Grade 8
Nominal Diameter	16.0 mm
Pitch	2.0 mm
Shear Strength	1034 MPa (Refer Table 2)

Design Example (Inch) Units

Type	1/2"-13 UNC, Socket Head Cap Screw
Nominal Diameter	0.500"
TPI	13
Tensile Strength	181,000psi (Refer Table 2)

Table 2 Strength, Bolt (Metric)

BOLT GRADE	Tensile strength MPa (minimum)
SAE Grade 1 1/4" to 1"	413
SAE Grade 5 1/4" to 1 1/2"	827
SAE Grade 7 1/4" to 1 1/2"	917
SAE Grade 8 1/4" to 1 1/2"	1034
ASTM A354	
BC 1/4" to 2 1/2"	862
BD 1/4" to 2 1/2"	1034
Socket head screw products	1250

Step Two: Determine tensile failure load of selected bolt

Min Thread Diameter	13.797mm (handbook)
Shear Area	149.5mm ² (calculated)*
Tensile Failure Load	154.59kN (calculated)#

*Area based on minor thread diameter.
#Parent material shear strength must exceed this.

Step Three: Determine shear strength of parent material for the installation of the insert (refer Table 3)

Type	2024 Wrought Aluminum, T62 temper
Shear Strength	283 MPa (Refer Table 3)

Table 3 Shear Strength, Parent Material (Metric)

ALLOY	TEMPER	SHEAR STRENGTH MPa (typical)
SHEET & PLATE		
1200	0	62
2024	T62	283
5005	H34	97
5251	H34	138
5083	0	172
5083	H321	179
7075	T6	331
EXTRUSIONS (including machine rod)		
1350	H112	55
2011	T3	221
2011	T6	234
2014	T6	290
6060	T5	117
6061	T6	207
CASTINGS (Properties refer to test bars only)		
CA401 {LM6+ A413#}	F1-Sand	125
Heat Treating Alloy		
AC601 {LM25+ A356#}	T6-Sand	125
AC601 {LM25+ A356#}	T5-Sand	180
AC601 {LM25+ A356#}	T6-Perm	190

Shear strength of standard parent materials, (indication only refer supplier for specific properties)

*Nearest British Equivalent

#Nearest US Equivalent

Table 2 Strength, Bolt (Inch)

BOLT GRADE	Tensile strength psi (minimum)
SAE Grade 1 1/4" to 1"	60,000
SAE Grade 5 1/4" to 1 1/2"	120,000
SAE Grade 7 1/4" to 1 1/2"	133,000
SAE Grade 8 1/4" to 1 1/2"	150,000
ASTM A354	
BC 1/4" to 2 1/2"	125,000
BD 1/4" to 2 1/2"	150,000
Socket head screw products	181,000

Min Thread Diameter	0.407" (handbook)
Shear Area	0.130"² (calculated)*
Tensile Failure Load	23,550 Pounds Force (lbf) (calculated)#

*Area based on minor thread diameter.
#Parent material shear strength must exceed this.

Type	5083 Wrought Aluminum, annealed Condition
Shear Strength	25,000 psi (Refer Table 3)

Table 3 Shear Strength, Parent Material (Inch)

ALLOY	TEMPER	SHEAR STRENGTH psi (typical)
SHEET & PLATE		
1200	0	9,000
2024	T62	41,000
5005	H34	14,000
5251	H34	20,000
5083	0	25,000
5083	H321	26,000
7075	T6	48,000
EXTRUSIONS (including machine rod)		
1350	H112	8,000
2011	T3	32,000
2011	T6	34,000
2014	T6	42,000
6060	T5	17,000
6061	T6	30,000
CASTINGS (Properties refer to test bars only)		
CA401 {LM6+ A413#}	F1-Sand	18,000
Heat Treating Alloy		
AC601 {LM25+ A356#}	T6-Sand	18,000
AC601 {LM25+ A356#}	T5-Sand	26,000
AC601 {LM25+ A356#}	T6-Perm	27,000

Step Four, Determine the length of insert based on shear strength of parent material

Nominal Diameter	16.0 mm (Selected bolt)
Pitch	2.0 mm
Pitch Diameter (min)	17.299mm (Refer Taped Hole Data)

$$L = \frac{\text{Tensile Strength of Bolt}}{\text{Shear Circumference Strength of Hole} \times \text{Arbitrary Constant}}$$

L = Required length of fitted insert
Arbitrary Constant = 0.5
 (0.5 Based on shearing of the parent material occurring along the pitch diameter of the tapped hole)

$$L = \frac{1034 \times (13.797^2 \times /4)}{283 \times 17.299 \times 0.5}$$

$$L = 20.1\text{mm}$$

Conclusion:

For this application a 16mm diameter bolt has been selected. Insert engagement of 20.1mm was calculated. The suitable diameter of the insert can be determined by dividing the length of the insert by the diameter of the bolt.

For example:

$$\begin{aligned} L/\text{dia} &= 20.1\text{mm}/16\text{mm} \\ &= 1.26 \text{ select next highest size} \\ &\text{Therefore use a 1.5D insert} \end{aligned}$$

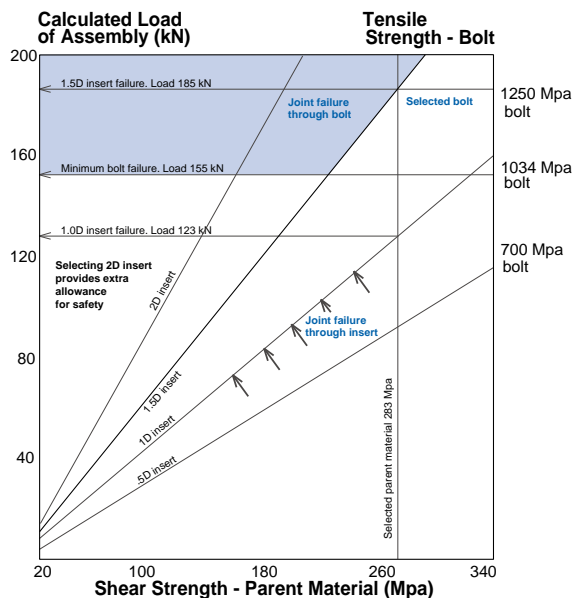

The shaded area in the graph indicates the region in which bolt failure will occur.

Note: Inserts are available in standard lengths which are multiples of the diameter. For example an insert with a length of 1.5D will measure one and a half times as long as the diameter when installed.

Note: The example above is an indication only. Professional engineering advice must be sought when exact design calculations are required.

Nominal Diameter	0.500" (Selected bolt)
TPI	13
Pitch Diameter (min)	0.550" (Refer Taped Hole Data)

$$L = \frac{\text{Tensile Strength of Bolt}}{\text{Shear Circumference Strength of Hole} \times \text{Arbitrary Constant}}$$

L = Required length of fitted insert
Arbitrary Constant = 0.5
 (0.5 Based on shearing of the parent material occurring along the pitch diameter of the tapped hole)

$$L = \frac{181,000 \times (0.407^2 \times /4)}{25,000 \times 0.550 \times 0.5}$$

$$L = 1.09"$$

Conclusion:

For this application a 1/2" diameter bolt has been selected. Insert engagement of 1.09" was calculated. The suitable diameter of the insert can be determined by dividing the length of the insert by the diameter of the bolt.

For example:

$$\begin{aligned} L/\text{dia} &= 1.09"/0.5" \\ &= 2.2 \text{ select next highest size} \\ &\text{Therefore use a 2.5D insert} \end{aligned}$$

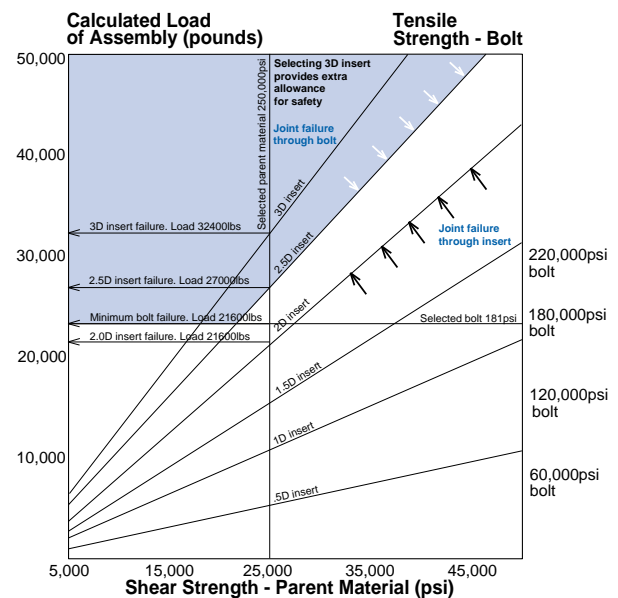

The shaded area in the graph indicates the region in which bolt failure will occur.

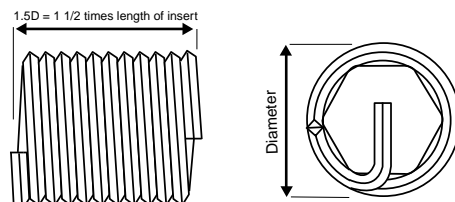

Thread Identification

Thread Identification And Drill Chart Metric

DIAMETER IN INCHES	THREAD SIZE MM	ISO COARSE			OTHER	ISO FINE			BA				
		DRILL SIZE				DRILL SIZE			DIAMETER				
		PITCH	INCH	MM		PITCH	INCH	MM	SIZE	MM	INCH	PITCH	DRILL
.079	2	.4		2.1					0	6.0	.236	1	6.2
.087	2.2	.45	No. 42	2.3					2	4.7	.185	.8	4.9
.098	2.5	.45	No. 37	2.6					4	3.6	.142	.66	3.8
.118	3	.5	1/8	3.2					6	2.8	.110	.53	2.9
.138	3.5	.6	No. 27	3.7					8	2.2	.860	.43	2.3
.157	4	.7	11/64	4.2					10	1.7	.670	.35	1.7
.197	5	.8	13/64	5.2									
.236	6	1	1/4	6.3									
.276	7	1	9/32	7.3									
.315	8	1.25	21/64	8.3		1	21/64	8.3					
.354	9	1.25		9.4		1		9.3					
.394	10	1.5	13/32	10.4	1*	1.25	13/32	10.25					
.433	11	1.5		11.5	1	1.25		11.25					
.472	12	1.75	31/64	12.5	1.25	1.5	31/64	12.25					
.512	13			13.5		1.5		13.25					
.551	14	2	37/64	14.5	1.25*	1.5	9/16	14.25					
.630	16	2	21/32	16.5		1.5	21/32	16.5					
.709	18	2.5	47/64	18.75	1.5*	2	23/32	18.5					
.787	20	2.5	13/16	20.75	1.5	2	13/16	20.5					
.866	22	2.5		22.75	1.5	2		22.5					
.945	24	3		24.75	1.5	2		24.5					

*M10 X 1, M12 X 1.25, M14 X 1.25, M18 X 1.5 - popular spark plug sizes sizes above M24 available on request.

Inch

DIAMETER		THREAD SIZE	THREADS PER INCH						DRILL SIZE					
INCHES	MM		UNC	BSW	UNF	BSF	BSF*	NPT*	UNC	BSW	UNF, SAE, BSF	BSP	NPT	
					(SAE)				INCH	MM	INCH	MM	INCH	MM
.86	2.18	#2	56		64				3/32	2.3	No. 37	2.3		
.990	2.51	#3	48		56				No.36	2.7		2.7		
.112	2.84	#4	40		48				No.31	3.0	No.31	3.0		
.125	3.17	#5 (1/8)	40	40	44		28	27	N0.29	3.4		3.3	3/8	9.9
.138	3.50	#6	32		40				N0.25	3.7	N0.26	3.7		
.164	4.16	#8	32		36				11/64	4.4	11/64	4.4		
.190	4.82	#10 (3/16)	24		32				13/64	5.1	13/64	5.1		
.187	4.76	3/16		24	32				13/64	5.0	13/64	5.0		
.216	5.49	#12 (7/32)	24	24					15/64	5.6				
.250	6.35	1/4	20	20	28	26	19	18	17/64	6.7	17/64	6.6	33/64	13.5
.312	7.93	5/16	18	18	24	22			21/64	8.3	21/64	8.2		
.375	9.52	3/8	16	16	24	20	19	18	25/64	9.9	25/64	9.8	21/32	17.0
.437	11.11	7/16	14	14	20	18			29/64	11.5	29/64	11.5		
.500	12.70	1/2	13	12	20	16	14	14	17/32	13.0	33/64	13.0	13/16	21.5
.562	14.28	9/16	12	12	18	16			19/32	14.5	37/64	14.5		
.625	15.87	5/8	11	11	18	14			21/32	16.5	41/64	16.25		
.750	19.05	3/4	10	10	16	12	14	14	25/32	19.75	49/64	19.5	1 1/64	27.0
.875	22.22	7/8	9	9	14	11			29/32	23.0	57/64	22.5		
1.000	25.40	1"	8	8	12 (14)	10	11	11 1/2	1 1/32	26.0	1 1/64	26.0	1 9/32	33.5
1.125	28.57	1 1/8"	7	7	12	9	11		1 5/32	29.5	1 5/32	29.5		
1.250	31.75	1 1/4"	7	7	12	9	11		1 9/32	33.0	1 9/32	32.5		
1.375	34.92	1 3/8"	6	6	12	8	11		1 13/32	36.0	1 13/32	36.0		
1.500	38.10	1 1/2"	6	6	12	8	11		1 17/32	39.0	1 17/32	39.0		

*Nominal diameters for BSP and NPT are not thread diameters but relate to the inside diameter of the pipe.

Screw Pitch Gauge

It is critical that inserts match the tapped hole exactly as some inch and metric are very close but only one is exactly right. A screw pitch gauge is the perfect tool to identify exact TPI or pitch. The bolt diameter should be measured and matched to the closest size over, relating to the TPI or pitch of the thread.

In general, major diameter of bolt or male thread will always be slightly less than the exact diameter listed in the thread identification and drill chart.

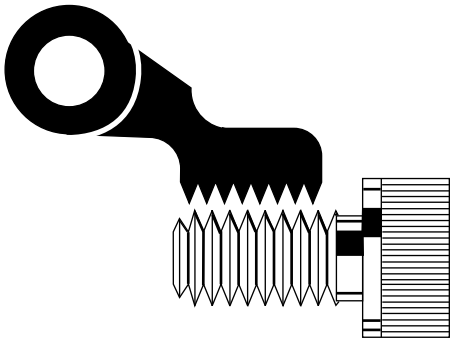

Drill Sizes

Drill sizes are recommended only. The nearest standard size drill above or below is generally quite suitable for repairs and in many instances, drilling is not necessary for stripped holes. For precision tolerances, the thread identification and drill chart is an accurate guide, but final size depends on material and machining conditions.

In practice BSW interchanges with UNC except at 3/16" and 1/2", SAE interchanges with UNF, except 1" UNF - 12 TPI, SAE - 14 TPI.

Thread Features

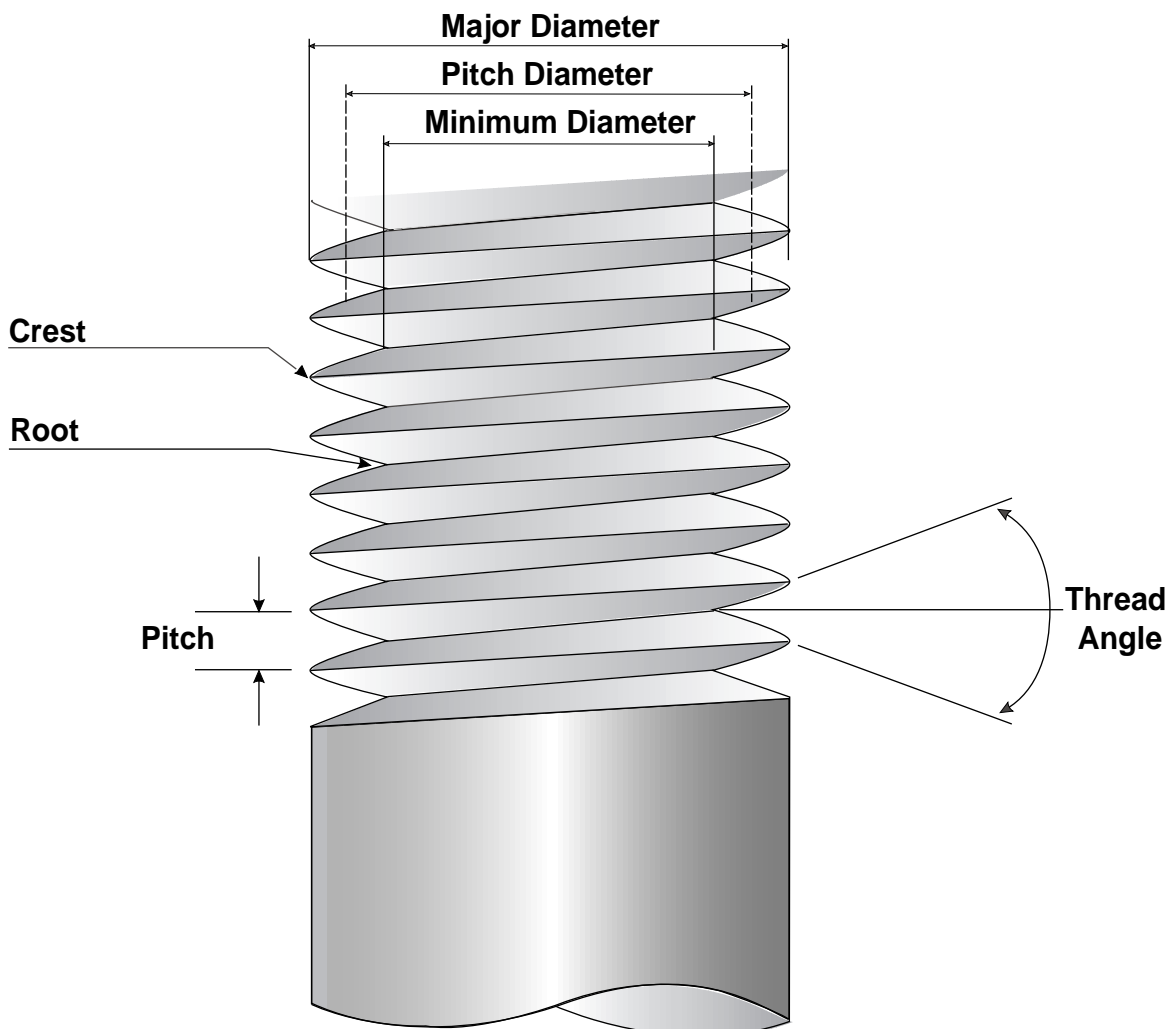

SI Units & Conversions for Characteristics of Mechanical Fasteners

PROPERTY	UNIT	SYMBOL	CONVERSION			APPROXIMATE EQUIVALENT
			FROM	TO	MULTIPLY BY	
Length	metre	m	inch	mm	25.4	25mm = 1 in
	centimetre	cm	inch	cm	2.54	300mm=1 ft
	millimetre	mm	foot	mm	304.8	1m=39.37
Mass	kilogram	kg	ounce	g	28.35	28g=1oz
	gram	g	pound	kg	.4536	1kg=2.2lb=35oz
	tonne (megagram)	t	ton (224lb)	kg	984.2	1t=2206lbs
Density	kilogram per cub. metre	kg/m ³	pounds per cu. ft	kg/m ³	16.02	16kg/m ³ =1lb/ft ³
Temperature	deg. Celsius	°C	deg. Fahr	°C	(°F-32)x5/9	0°C=32 °F
Area	square metre	m ²	sq. inch	mm ²	645.2	645mm ² =1 in ²
	squaremillimetre	mm ²	sq. ft	m ²	.0929	1m ² =11 ft ²
Volume	cubic metre	m ³	cu. in	mm ³	16387	16400mm ³ =1 in ³
	cubic centimetre	cm ³	cu. ft	m ³	.02832	1m ³ =35ft ³
	cubic millimetre	mm ³	cu. yd	m ³	.7645	1m ³ =1.3yd
Force	newton	N	ounce(Force)	N	.278	1N=3.6 oz ^f
	kilonewton	kN	pound(Force)	kN	.00445	4.4kN=1 lbf
	meganewton	MN	kip	MN	.00445	1kN=225 lbf
Pressure	bar	bar	MPa	bar	.1	1MPa=1bar
	megapascal	MPa	pound/in ² (psi)	MPa	.0069	1MPa=145 psi
	newton/sqmm	N/m ²	Kip/in ² (ksi)	MPa	6.895	7MPa=1ksi
Torque	newton-meters	N-m	inch-ounce	N-m	.00706	1N-m=140 in.oz
			inch-pound	N-m	.113	1N-m=9 in. lb
			foot-pound	N-m	1.356	1N-m=75 ft lb 1.4N-m=1 ft.lb

Hardness Comparison Table

Brinell 10m/m Ball 3000kg load.	Firth or Vickers 120kg	Rockwell		Brinell 10m/m Ball 3000kg load.	Firth or Vickers 120kg	Rockwell	
		C. Scale 120° Cone 150kg load.	B. Scale 1/16" Ball 100kg load			C. Scale 120° Cone 150kg load.	B. Scale 1/16" 100kg load.
800	-	72	-	276	278	30	105
780	1220	71	-	269	272	29	104
760	1170	70	-	261	261	28	103
745	1114	68	-	258	258	27	102
725	1060	67	-	255	255	26	102
712	1021	66	-	249	250	25	101
682	940	65	-	245	246	24	100
688	905	64	-	240	240	23	99
652	867	63	-	237	235	22	99
262	803	62	-	229	226	21	98
614	775	61	-	224	221	20	97
601	746	60	-	217	127	19	96
590	727	59	-	211	213	18	95
576	694	57	-	206	209	17	94
552	649	56	-	203	201	16	94
545	639	55	-	200	199	15	93
529	606	54	-	196	197	14	92
514	587	53	120	191	190	13	92
502	565	52	119	187	186	12	91
495	551	51	119	185	184	11	91
477	534	49	118	183	183	10	90
461	489	47	117	175	174	7	88
444	474	46	116	170	171	6	87
427	460	45	115	167	168	5	87
415	435	44	115	165	165	4	86
401	413	43	114	163	162	3	85
388	401	42	114	160	159	2	84
374	390	41	113	156	154	1	83
370	385	40	112	154	152	-	82
362	280	39	111	152	150	-	82
351	361	38	111	147	147	-	80
346	352	37	110	147	147	-	79
331	335	36	109	143	144	-	79
323	320	35	109	141	142	-	77
311	312	34	108	140	135	-	75
301	305	33	107	135	135	-	75
293	291	32	106	130	130	-	72
285	285	31	105	-	-	-	-

Relevant Insert Standards

Military Specifications

MS122076 thru MS122275
MS124651 thru MS12444850
MS21209
MS33537
MIL-I-8846
MIL-STD-1312
MIL-L-8937
MIL-L-46010
MIL-T-21309

Federal Specifications

FED-STD-H28
QQ-A-250
QQ-P-35
QQ-P-416
QQ-Z-325
TT-M-261
PP-H-1581

SAE Specification

MA1565
MA1567
MA3279 / MA3280 / MA3281
MA3329 / MA3330 / MA3331
AS 1370
AMS 2400
AMS 2402
AMS 2410
AMS 2411
AMS 2427
AMS 2460
AMS 2645

AECMA Specifications (European Aerospace Standards)

EN 2942
EN 2943
EN 2944
EN 2945
EN 3044
EN 3542

SBAC Specifications

AGS 3600

AGS 3700

AS 6733
AS 8455

LN Specifications

LN 9039
LN 9499

General Electric Specifications

GE C9F1
GE N926

DIN Specifications

DIN 8140

British Standard Specifications

BS 4377
BS 7751.1

BS 7751.2
BS 7752
BS 7753

Recoil manufacture to many standards and are available upon request.

Title

Insert, Corrosion Resistant, Helical Coil, Coarse Thread
Insert, Corrosion Resistant, Helical Coil, Fine Thread
Insert Screw Thread - Screw Locking
Insert - Standard Dimensions, Assembly
Inserts, Screw Thread, Helical Coil
Fastener, Test Methods
Lubricant, Solid Film, Heat Cured, Corrosion Inhibiting NATO Code No. S-1738
Lubricant, Solid Film, Heat Cures, Corrosion Inhibiting
Tools For Inserting and Extracting Helical Coil Inserts

Title

Screw Thread Standards for Federal Service
General Specifications for Aluminium and Aluminium Alloy, Plate and Sheet
Passivation Treatments for Corrosion Resisting Steel
Plating, Cadmium (Electrodeposited)
Plating, Zinc (Electrodeposited) - (Superseded by ASTM B633-85)
Methyl-Ethyl-Ketone (for use in organic coatings)
Shipment and storage of Packing for Hardware (fastener and related items) Packaging.

Title

Inserts, Metric Screw Thread, Procurement Specification
Inserts, metric, Standard Dimensions, Assembly
Inserts, Screw thread, Metric, Free-Running
Inserts, Screw Thread, Metric, Screw Locking
Aerospace Standard - Metric Screw Threads MJ Profile
Aerospace Material Standard for Cadmium Plating
Aerospace Material Standard for Zinc Plating
Electroplating Standard, Silver, Nickel Strike
Electroplating Standard - Silver, High Temperature Applications
Aluminium Plating, Ion Vapour Deposition
Magnetic Particle Inspection
Fluorescent Dye Penetrant Inspection

Title

Insert, Screw Thread, Self Locking, (Inco x 750) SilverPlated
Wire Thread Inserts, (self-locking), Technical Specification
Insert, Screw Thread, Self-Locking, Cres (Z10-CN18-09), Unplated
Assembly with Self-Locking inserts
Installation of Self-Locking Thread inserts - Design Dimensions
Insert, Screw Thread, Self-Locking, (Inco x 750) Dry Film Lubricated.

Title

Insert, Screw thread, metric, screw locking, helical coil corrosion resistant steel
DTD 734 cadmium plated
Insert-screw thread, unified screw locking, helical coil, h.r. alloy BS HR 503 Source control drawing
UNF Unplated
UNF Cadmium plated

Title

Aerospace, wire thread inserts, assembly and special tools
Aerospace, wire thread inserts, screw locking, assembly and special tools

Title

Wire Insert
Stainless steel Wire Locking Inserts for temperatures up to 700 deg F

Title

Wire thread inserts for ISO metric screw threads - tapped holes for thread inserts thread tolerances.

Title

Tapping of holes to receive wire thread inserts (ISO metric threads)
Prevailing torque type wire thread inserts - Specifications for ISO metric course pitch threads
Prevailing torque type wire thread inserts - Specifications for ISO metric fine pitch threads
Free running type wire thread inserts - Specifications for ISO metric course pitch threads
Performance of prevailing torque wire thread inserts



Complete Thread Fastener Systems

As a part of the KTI Group of companies Recoil can provide a complete range of threaded fastener systems.

K-Sert® Inserts and Studs

Solid one piece K-Sert® insert and studs provide high resistance to torque-out and pull-out utilising keys that are driven into parent material. Styles include miniature, blind-end, solid and floating types.



Kelox® Inserts and Studs

Kelox® inserts and studs typically require smaller diameter installation holes than other staked, solid-bushing type inserts and studs. Smaller installation holes result in weight savings and reduced edge distance requirements.



Recoil Wire Thread Inserts

Designed to be slightly oversized, these helically-coiled inserts compress as they are inserted into the prepared hole to achieve maximum surface contact with the parent material.



Thin Wall® Inserts

Thin-Wall® inserts are a logical choice when space limitations result in minimum boss dimensions, but requirements demand a maximum degree of thread protection and fastening integrity.



Ring-Lox™ Inserts, Studs and Lockrings

Ring-Lox™ inserts and studs receive their high torsional resistance capability from a lockring serrated on its internal and external surfaces. Lockrings simultaneously engage a serrated collar on the fastener and self-broach into soft base materials.



Recoil Inserts and Repair Kits

Recoil thread repair kits contain a quality HSS tap, installation tool, precision stainless steel inserts and instructions in a sturdy reusable container. Recoil has a full range of problem solving repair kits available in single or multiple size format.





Australia
Recoil Pty (Head Office)
ACN 073 750 428
20 Stamford Road
Oakleigh Vic 3166
Telephone +61 3 9563 1500
Facsimile +61 3 9563 1980
Email sales@recoil.com.au
Website <http://www.recoil.com.au>

USA
Recoil
1051 Third Avenue SW
Carmel IN 46032
Telephone (317) 846 8830 or (800) 826 2884
Facsimile (317) 846 8858 or (800) 5-RECOIL
Email sales@recoilusa.com

United Kingdom
Recoil (Europe) Ltd
Unit 7, Fallings Park Industrial Estate
Park Lane Wolverhampton WV 109QE
Telephone (01902) 307 800
Facsimile (01902) 307 829
Email postmaster@recoil.demon.co.uk

Belgium
Recoil Marketing BVBA
Langestraat 103
B-9300 Aalst, Belgium
Telephone 32(0) 5377 0102
Facsimile 32(0) 5377 4310
Email recoilbel@pophost.eunet.be

Singapore
Recoil Pte Ltd
Blk 194 Pandan Loop #07-16
Pantech Industrial Complex
Singapore 128383
Telephone (65) 778 9233
Facsimile (65) 778 0151
Email jazpac@signet.com.sg

Thailand
Recoil Co. Ltd
33/260 Mooban Tor Ruam Chok 11
Chok Chai 4, Ladprao 53 Road
Ladprao, Bangkok 10230
Telephone (+662) 639 0693
Facsimile (+662) 639 0638

A Kaynar Technologies Group

Notices and Disclaimers: We reserve the right to make changes without notice in our products and in the information published about them. The statements and information in this publication are only for general guidance, and are not warranties or binding descriptions.

Requests for more information are welcome. The user assumes full responsibility for his or her applications. There is no warranty of fitness for a particular purpose. No one is authorised by our company to make oral warranties.

Our exclusive warranty and remedy are stated in our written terms and conditions of sale. The remedy is essentially repair, replacement or refund by us for a one year warranty period. All other remedies and liability from any cause for costs, losses and damages of any kind including consequential are excluded.

Our standard terms and conditions of sale, unless modified in writing and signed by our authorised representatives, apply exclusively to all orders, including telephone and facsimile orders.